



Jayco[®] Generations of family fun.

REDHAWK & REDHAWK *SE*

2020 OWNER'S MANUAL



eco advantage™

THE JAYCO ECOADVANTAGE IS OUR COMPANY'S COMMITMENT TO PROTECTING THE ENVIRONMENT. Through Jayco's company-wide sustainability program, we're creating better ways to build better RV's using fewer natural resources. Already, our initiative has created significant impact. As of 2014 our company has:

Recycled



- 7,192 tons of wood
- 2,354 tons of scrap metal
- 1,428 tons of cardboard and paper

Conserved



- 9,997,400 gallons of fresh water, enough to meet the daily needs of 133,293 Americans.
- 34,277 gallons of gas, enough for Americans to drive more than 957,600 miles.
- Enough electricity to power 1,745 homes for that year.

Saved



- 60,900 mature trees.
- Enough landfill airspace to meet the annual disposal needs of a community of 44,683 people.

We're proud of our results, and we know those numbers show that a little initiative can go a long way. The Jayco EcoAdvantage is our way of making sure endless generations can enjoy the Great Outdoors.

Table of Contents

SECTION 1: WARRANTY & SERVICE

Factory Tours	10
Options and Equipment	10
Dealer Responsibility	10
Customer Relations	10
Obtaining Emergency Warranty Repair	11
To Contact Us	12
About This Manual	12
Warranty Packet	12
Chassis Guide	13
Safety Alerts	13
Reporting Safety Defects	14
Customer Responsibility	14
Change Of Address/Ownership	15
Suggestions For Obtaining Service	15
Obtaining Service For Separately Warranted Items	15
Obtaining Service At Our Customer Service Facility	16
Parts and Accessories	16

SECTION 2: OCCUPANT SAFETY

Secondary Means of Escape (Exit Window)	23
<i>Exit Window Label</i>	
Fire Safety	24
Fire Extinguisher	24
Smoke Alarm	25
Combination Carbon Monoxide / Propane Alarm	26
Formaldehyde	29
Extended Or Full Time Usage	30
Cold Weather Usage	30
Condensation	30

SECTION 3: PRE-TRAVEL INFORMATION

Vehicle Labels	31
Weight Terms	31
Weight and Capacity Labels	32
<i>Towing and Braking Warning Label</i>	
<i>Upper Section Federal OCCC Weight Label</i>	
<i>Lower Section Federal OCCC Weight Label</i>	
<i>Federal Certification Label</i>	
Loading Your Motorhome	33
Trailer Plug	34
Weighing Your Motorhome	34

SECTION 4: VEHICLE OPERATION

Vehicle Operation	37
Braking and Stopping	37
Parking Brake	37
<i>Towing and Braking Label</i>	
Using The Rear Hitch	38
Power Entrance Step	39
Entrance Door	39
Driver and Passenger Seat	40
Seat Belts	41
Child Safety Restraint Systems	41
Outside Rearview Mirrors	42
Power Remote Mirrors (if so equipped)	42

Table of Contents

Rear Vision Camera	42
<i>Remote Mirror Control / Mirror Heat Control</i>	
Campsite Hook-Up	43
Lippert Level UP® Motorhome Leveling System (if so equipped)	43
Leveling Control Panel Callouts	44
Auto Level Sequence	45
For Diesel Units with Air Bag Suspensions ONLY	45
User Alarm Mode	45
Low Voltage Signal	46
Automatic Leveling Procedure	46
Manual Leveling Procedure	46
Jack Retract Procedures	47
Emergency Stopping	48
Jacks – Manual Override	48
Drive Away Protection System	48
Jacks Down Alarm	48
Recommended Fluid	48
Emergency Towing	49
Front Axle Tire Alignment	49
Wheel Lug Nuts/Wheel Liners	50
Tires	51
Changing a Tire	53
Awnings (if so equipped)	53
Awning Care	53
Power Awnings (if so equipped)	54
Carefree® Longitude Awnings (if so equipped)	54
Electric Patio Awning With Remote Control	54
In Motion Detector (if so equipped)	54
Carefree® Travel'r Awnings (if so equipped)	56
<hr/> SECTION 5: SLIDEOUT SYSTEMS	
Electric Slide Room(s) (if so equipped)	59
General Slideout Operation	59
<i>Slideout Overlap-Outside</i>	
General Slideout Troubleshooting Checklist	60
Flush Floor Slideout	60
Schwintek In-Wall Slideout System	62
Norco Slideout System	65
<i>Fig.1 Slideout Controller</i>	
Power Gear Slim Rack Slideout System	68
Power Gear Ram Slideout System	73
<hr/> SECTION 6: ELECTRICAL SYSTEM	
The Electrical System	75
In Case Of An Electrical Fire	75
Controls and Switches	76
Command Center	76
<i>Command Center Panel</i>	
<i>Command Center Panel w/Switch Modules</i>	
GFCI Receptacle	77
Testing The Campsite Power Connection	77
Power Converter	79
Converter with Charge Wizard (if so equipped)	80
12-Volt DC System	81

Table of Contents

Batteries	82
House Batteries	82
Dry Camping	82
Battery Replacement	83
12-Volt Battery Disconnect	83
Battery Isolator Solenoid (if so equipped)	84
Battery Isolation Manager (if so equipped)	84
Auxiliary Start System (if so equipped)	84
Load Center	84
Automatic Transfer Switch (ATS)	85
120-Volt Circuit Breakers	85
Approximate Electrical Load Ratings	87
120-Volt (30 AMP) AC System (if so equipped)	88
30-amp Power Cord (if so equipped)	88
Generator	89
Before Starting the Generator	90
Maintenance	90
Starting the Generator	91
To Manually Start the Generator	91
Automatic Generator Start (AGS) (if so equipped)	91
Solar Prep (if so equipped)	92
Replacing Light Bulbs	92
<hr/> SECTION 7: FUEL & PROPANE SYSTEM <hr/>	
Diesel Fuel and Fill	93
Fuel Selection	93
DEF Fluid	93
Fuel Safety	94
Exhaust Gas Fumes	95
Propane Gas System (if so equipped)	95
<i>Propane Label</i>	
Propane Gas Container	96
Servicing or Filling	97
LP Gas Container Overfill	97
<i>Propane System Label</i>	
Propane Regulator	98
Propane Use and Safety	99
Using The Propane System	99
<i>Propane System Label</i>	
Cooking With Propane Gas	100
<i>Cooking / Comfort Heating Label</i>	
Calculating Propane Gas Usage	100
Traveling With Propane	101
<i>Refueling Warning Label</i>	
<hr/> SECTION 8: PLUMBING SYSTEM <hr/>	
Plumbing System	103
Plumbing System Maintenance	103
Monitor Panel	103
<i>Monitor Panel</i>	
<i>Command Center</i>	
Fresh Water System	104
Water Pressure Regulator (customer supplied)	105
<i>Water Pump Strainer</i>	
Water Purification System (if so equipped)	106
<i>Filter Housing</i>	

Table of Contents

Draining the Fresh Water System	107
<i>Exterior Fresh Water Drain</i>	
<i>Low Point Drains</i>	
Utility Center	108
<i>Potable Water Only Label</i>	
Water Control Valve Operation	109
Water Heater Bypass – 3 Valves/No Utility Center (if so equipped)	111
Sanitizing the Plumbing System	112
Winterizing with Antifreeze Method (with Utility Center)	116
Winterizing with Antifreeze Method (no Utility Center)	117
Water Heater	119
Operating Instructions	119
<i>Anode Rod Replacement Chart</i>	
High Altitude Deration	120
Pressure and Temperature Relief Valve	121
Maintenance	121
Outside Shower (if so equipped)	122
Draining and Winterization	122
Faucets	123
Bathroom Tub / Shower	123
Black/Grey Water System and Tanks	123
Black and Grey Tank Drains	125
<i>Black/Grey Tank Drain and Valves</i>	
Black Tank Flush (if so equipped)	126
<i>Tank Flush Inlet</i>	
Tank Heaters (if so equipped)	127
Toilet	128

SECTION 9: HEATING & COOLING

Air Conditioner	129
Power Roof Vent (if so equipped)	129
<i>Attic Fan Control</i>	
Furnace	130
Fireplace (if so equipped)	130

SECTION 10: APPLIANCES

Microwave	131
Cooking Safety	131
Cooktops; Range and Oven (if so equipped)	132
LP Gas Grill Hookup (if so equipped)	133
Attaching the “Quick Coupler” Connection	133
<i>Quick Coupler Connection</i>	
Range Hood (if so equipped)	134
Refrigerator	135
Water Heater – See Plumbing Section	137

SECTION 11: ELECTRONICS

HDTV Antenna/Satellite System	139
Exterior Entertainment Center (if so equipped)	140
<i>Antenna Power Supply</i>	
Antenna Power Supply (if so equipped)	140
Satellite (if so equipped)	140

Table of Contents

SECTION 12: INTERIOR

Cleaning the Interior	141
Décor Glass (if so equipped)	141
Furniture Upholstery	141
Sofa and Dinette	143
Free Standing Dinette Chairs (if so equipped)	145
Pantry or Hutch (if so equipped)	145
Countertops	146
Flooring	146
Privacy Drape Installation	147
Bed Storage	147
Bunk Beds (if so equipped)	148
Bunk Bed Ladder (if so equipped)	148
Cab-Over Bunk Bed (if so equipped)	149

SECTION 13: EXTERIOR

Cleaning The Exterior	151
Frame	153
Front Axle Tire Alignment	153
Mud Flap (if so equipped)	154
Exterior Roof and Sidewall Vents	154
Windows	154
Exterior Ladder (if so equipped)	155
Sealants	156

SECTION 14: TRAVEL/CAMPING/STORAGE CHECKLISTS

Travel Checklist	157
Motorhome Storage	158

SECTION 15: ADDITIONAL INFORMATION

Featured Components Quick Reference Chart	161
Vehicle Maintenance Record	163
Ownership Notification	165



WARNING: Read all instructions in this manual and component manufacturer supplied information before using your RV.

This manual has been provided by your recreational vehicle manufacturer for the sole purpose of providing instructions concerning the operation and maintenance of this recreational vehicle. Nothing in this manual creates any warranty, either expressed or implied.

The owner's failure to provide required service and/or maintenance could result in the loss of warranty. Please review the limited warranty and the limited warranties that apply to specific components offered with this vehicle.

Instructions are included in the manual for operating various components which are optional on some RV's or may not be available on your particular model. **"If so equipped" does not indicate or imply that the component(s) or option(s) were at any time available, or can be retrofitted to your model.** In addition, the owner should refer to individual manufacturer's operating instructions contained in the owner's packet.

SECTION 1: WARRANTY & SERVICE

Congratulations! Thank you for selecting a Jayco recreation vehicle. We are excited to welcome you to our growing RV family. We are committed to being the most respected name in RVs. We invite you to drop by our Visitors Center located in Middlebury, Indiana. Jayco recreation vehicles are manufactured for use as temporary living quarters for recreation, camping and travel uses, all as defined by the bylaws of the Recreation Vehicle Industry Association (RVIA).

This recreation vehicle is not intended for use as a full-time residence or for commercial use. Commercial use means using the recreation vehicle as a business asset such as a mobile office or using the recreation vehicle for lease or rental purposes.

Jayco reserves the right to discontinue or change specifications or design at any time without notice and without incurring any obligation whatsoever. Recreation vehicles built for sale in Canada may differ to conform to Canadian Codes.

Factory Tours

To book a factory tour or check on available tour times (free admission, closed holidays) please log on to <https://www.jayco.com> and hold the mouse pointer on the **ABOUT JAYCO** heading. Select “**FACTORY TOURS**” from the drop down menu that opens.

Options and Equipment

Jayco recreation vehicles are available in several sizes and models, so accessories and components may differ slightly between models. Some equipment described in this manual may not apply to your recreation vehicle.

Jayco reserves the right to discontinue or change specifications or design at any time without notice, and to make additions or improvements without incurring any obligations upon itself to install these changes on its products previously manufactured. Recreation vehicles built for sale in Canada may differ to conform to Canadian Codes.

Dealer Responsibility

At the time of sale of the new recreation vehicle, your Jayco dealer is expected to:

- Deliver your recreation vehicle in the best condition possible. Your recreation vehicle must pass the dealer’s pre-delivery inspection (PDI), including all systems tests.
- Provide orientation of the recreation vehicle, its systems, components and operation.
- Request that you read all warranty information and explain any provision not clearly understood.
- Ensure you receive the Warranty Packet. Your dealer can assist you in completing the OEM warranty cards or registrations, and locate any required component model or serial numbers.
- Complete and return the “Warranty Registration and Customer Delivery Form” to Jayco within 10 days of delivery to activate the applicable warranty coverage.

The **Limited Warranty** is activated only after Jayco receives a signed and dated “Warranty Registration and Customer Delivery Form” from your dealer.

Customer Relations

Jayco has empowered its dealers to make warranty and repair decisions.

If a special circumstance occurs that requires information from Jayco, we have asked your dealer’s service management to make the contact on your behalf. **This is why you should always talk to your dealer’s service management first.**

- Customer name and current location.
- Phone number where you can be reached.

- 17-digit chassis Vehicle Identification Number (VIN) or 9-digit Serial.
- The current vehicle mileage (motorhomes).
- Your date of purchase.
- If applicable, the component description, serial number and model number.
- A detailed description of the concern.
- The name of your selling dealer.
- If different from above, the contact information for the RV repair facility you are contacting Jayco to discuss.

An important note about alterations and warranties

Installations or alterations to the original equipment vehicle as distributed by Jayco are not covered by the Jayco Limited Warranty. The special body company, assembler, equipment installer or up fitter is solely responsible for warranties on the body or equipment and any alterations (or any effect of the alterations) to any of the parts, components, systems or assemblies installed by Jayco. Jayco is not responsible for the safety or quality of design features, materials or workmanship of any alterations by such suppliers.

Obtaining Emergency Warranty Repair

1. Call 1-(800)-283-8267 or use our website dealer locator to find an authorized Jayco dealer in your area. Contact them for an appointment; they will handle all warranty repair billing and returned parts for you.
2. If you cannot locate an authorized Jayco dealer near you, ask the campground staff for referrals or check the local telephone yellow pages. Or contact Jayco Customer Service or your selling dealer for assistance in locating a repair facility.
 - Contact the RV repair facility to discuss your situation and make an appointment. Ask how their billing will be handled. They may choose to bill Jayco directly; otherwise, you are expected to pay them.
 - Have the RV repair facility inspect your RV. Either they or you must call Jayco Customer Service to discuss applicable warranty coverage prior to any repair work being performed.
 - Jayco Customer Service will issue an authorization number upon warranty repair approval and advise if any original parts need to be returned.
 - Once Jayco Customer Service has issued an authorization number, the RV repair facility may begin actual repair to your RV.
 - Inspect the completed repair work thoroughly. If you are not satisfied, communicate that immediately to the RV repair facility management. Make sure you are satisfied with the repair before you pay or leave the premises.

For reimbursement, either you or the RV repair facility must send a copy of your itemized repair bill and all requested return parts by UPS (regular ground, freight pre-paid) within 60 days of the completed repair date.

To expedite processing your warranty claim, include your name, address, phone number, RV 17-digit VIN and authorization number. If returning parts, include a copy of your return freight bill.

Obtaining weekend or after business hours repair assistance

If an authorized Jayco dealer is not located nearby, contact your selling dealer for assistance. If your dealer is closed, check with the campground staff or telephone yellow pages for an RV repair facility. Have the item repaired and contact Jayco Customer Service immediately the following business day.

Failure to contact Jayco Customer Service, unauthorized or improper warranty repairs, or failure to return requested original parts may result in loss of reimbursements and/or loss of warranty.

SECTION 1: WARRANTY & SERVICE

To Contact Us

Mailing address

Jayco, Inc.
Customer Service
P.O. Box 460
903 S. Main Street
Middlebury IN 46540
Phone (toll-free)
Phone (local)
Fax (toll-free)
Brochure request
Parts email
Service email
Website

Shipping address

Jayco, Inc.
Customer Service
100 Bontrager Drive
Bldg 42 Door 4220
Middlebury IN 46540
(800) 283-8267
(574) 825-0608
(866) 709-9139
info@Jayco.com
parts@Jayco.com
service@Jayco.com
www.Jayco.com

Jayco Travel Club

All owners of Jayco recreation vehicles are eligible for membership in the Jayco Travel Club.

The club promotes family camping and the active use of your RV with others who have similar interests in the RV lifestyle.

One "International Rally" is held each year in various locations around the United States and Canada. In addition, the club offers a variety of local and regional activities throughout the year.

By belonging to the Jayco Travel Club, you will find new ways to enjoy your RV and make friends all across the country.

For more information, please visit www.Jaycorvclub.com or call 1-800-262-5178.

ABOUT THIS MANUAL

This manual is a guide to operation of the features, equipment and controls in your recreation vehicle. If you find components vary significantly from what is described, please contact your dealer to ensure you have the correct information. Nothing in this manual creates any warranty, either expressed or implied.

This Owner's Manual and Warranty Packet are to be considered permanent components of the vehicle. Keep them in your recreation vehicle at all times for personal reference. If the recreation vehicle is sold, they should remain with the vehicle for the next owner. Nothing in this manual creates any warranty, either expressed or implied, nor does it cover every possible detail of equipment, standard or option, installed on or in your recreation vehicle.

Information, illustrations and specifications in this manual reflect the most current available at the time of publication approval, are subject to change and not intended to indicate actual size.

WARRANTY PACKET

There are components that are excluded from the vehicle warranty, or are warranted separately by their own individual manufacturer's limited warranty. The Warranty Packet contains these component manufacturer supplied manuals or information sheets, warranty cards and/or registrations. Consult this information for questions regarding operating, maintenance, servicing instructions and warranty coverage. It is important you complete and mail warranty cards and registrations within the prescribed time limits to avoid loss of warranty coverage.

CHASSIS GUIDE

Throughout this manual, frequent reference is made to the vehicle's Chassis Guide. The Chassis Guide includes the owner's manual provided by the manufacturer of the chassis on which this motorhome is built, warranty cards and/or registrations. It also includes pertinent information regarding the transmission, tires, etc. Consult the Chassis Guide for operating safety, maintenance, servicing instructions and warranty coverage. The Chassis Guide should be considered a permanent component of the vehicle and kept in the motorhome at all times for reference.

SAFETY ALERTS

Throughout this manual, certain items are labeled **NOTE**, **CAUTION**, **WARNING**, and **DANGER**. These terms will alert you to precautions that can involve risk to your vehicle or to your personal safety.

Read and follow them carefully. National Safety Associations and organizations require many of the instructions listed. Always use the appropriate safety gear when servicing or maintaining your recreation vehicle. Please call your dealer or our customer service representatives if you are unsure how to proceed.

These signal words indicate precautions and potential situations, which if not avoided, may result in personal injury, property damage, or damage to your recreation vehicle. These precautions are listed in the appropriate areas in this Owner's Manual, and in the information contained in the Warranty Packet, and on safety labels affixed to your recreation vehicle. Read and follow them carefully.



NOTE: Gives helpful information.



This is the safety alert symbol. It is used to alert you to potential personal injury hazards. Obey all safety messages that follow this symbol to avoid possible injury or death.

NOTE

Indicates a potential situation that, if not avoided, may result in property damage or damage to your motorhome.



CAUTION

Indicates a potentially hazardous situation that, if not avoided, may result in minor or moderate injury. It may also be used to alert against unsafe practices.



DANGER

Indicates an imminently hazardous situation that, if not avoided, will result in death or serious injury. This alert information is limited to the most extreme situations.

SECTION 1: WARRANTY & SERVICE

WARNING

Indicates a potentially hazardous situation that, if not avoided, may result in death or serious injury.

REPORTING SAFETY DEFECTS

In the United States: If you believe that your recreation vehicle has an alleged defect which could cause a crash or cause injury or death, you should immediately inform the National Highway Traffic Safety Administration (NHTSA), in addition to notifying our Customer Service Department.

If NHTSA receives similar complaints, it may open an investigation, and if it finds that a safety defect exists in a group of vehicles, it may order a recall and remedy campaign.

However, NHTSA cannot become involved in individual problems between you, your dealer or your vehicle manufacturer. For additional information, please refer to the NHTSA website at www.safercar.gov.

To contact NHTSA by phone:

Call the Department of Transportation (DOT) Vehicle Safety Hotline at 1-888-327-4236, and a NHTSA representative will record your complaint information (TTY: 1-800-424-9153 or 1-202-484-5238).

To Contact NHTSA by mail:

Office of Defects Investigations/CRD
NVS-216
1200 New Jersey Ave SE
Washington, DC 20590

In Canada: If you believe your vehicle has an alleged safety defect, you should contact Transport Canada and our Customer Service Department immediately. Transport Canada prefers to be called instead of posted mail or email as it enables their investigators to confirm that your information is correct, and to answer your questions accurately. For additional information, please refer to the Transport Canada website at www.tc.gc.ca.

To contact Transport Canada by phone:

Call 1-800-333-0510 (or 1-613-993-9851 if you are calling from the Ottawa region) and ask to speak to a defect investigator.

To contact Transport Canada by mail:

Road Safety and Motor Vehicle
Regulation Directorate
Transport Canada
Tower C, Place de Ville
330 Sparks Street
Ottawa, Ontario K1A 0N5

CUSTOMER RESPONSIBILITY

It is important you read and understand all instructions and precautions before operating the recreation vehicle. Even if you are an experienced RV'er we encourage you to thoroughly read this Owner's Manual, as well as the information contained in your Warranty Packet and Chassis Guide (motorized only).

As technology advances, new improvements enter the RV industry every day, and each RV manufacturer has its own unique manufacturing process.

Familiarize yourself with the Limited Warranty applicable to your recreation vehicle. There are components that are excluded or warranted separately by their individual manufacturer's limited warranty (refer to the Warranty Packet or Chassis Guide if applicable).

As the new owner of the recreation vehicle, you are responsible for regular and proper maintenance performed in accordance with this manual and the OEM manuals. Regular and proper maintenance will help prevent conditions arising from neglect that are not covered by the limited warranty. It is your responsibility and obligation to return your vehicle to your dealer for repairs and service.

CHANGE OF ADDRESS/OWNERSHIP

Please notify our Customer Service Department as soon as possible of a change of address by writing or calling us. For notification of a change of ownership, please fill out the appropriate form located in this manual and mail it to Customer Service along with documentation showing proof of ownership. Please include your current vehicle mileage (motorized only).

SUGGESTIONS FOR OBTAINING SERVICE

To help ensure your dealer provides the level of service you expect, here are some suggestions we would like to make:

Contact your dealer at once... Do not wait until you are ready to use your RV. Your dealer may not be able to service it immediately and/or the repair may require parts be ordered. The dealer's service department is busiest on Mondays, Fridays and before the holidays.

Prepare for the appointment... If you are having warranty work performed, be sure to have the right papers with you. Take your warranty folder and have your vehicle information available. All work to be performed may not be covered by the warranty. Discuss additional charges with the service personnel.

Prepare a list... Provide your dealer with a written list of specific repairs needed. It is important that you provide any vehicle repair history to the dealer's service personnel.

Keep a maintenance log of your vehicle's service history. This can often provide a clue to the current issue.

Be reasonable with your requests... If you leave a list with several items and you need your vehicle returned back by a specific time, discuss the situation with the dealer's service personnel and list your items in order of priority. This may include making a second appointment for work not completed or parts that the dealer may need to order.

Don't expect to look over the technician's shoulder... Please don't be offended if you are told you cannot watch the work being done. Some insurance requirements forbid admission of customers to the service area.

Inspect the work performed... Finally, check out the service or repair job when you pick up your vehicle. Notify the dealer's service personnel immediately of any dissatisfaction. If you cannot return the vehicle immediately for repair, make an appointment as soon as possible.

Please be aware that all service shops require notification of any issues with their repairs within a specified time limit. Make sure you are familiar with their repair policies.

OBTAINING SERVICE FOR SEPARATELY WARRANTED ITEMS

Your selling dealer is responsible for servicing your recreational vehicle before delivery, and has an interest in your continued satisfaction. We recommend your dealer perform all inspection, warranty and maintenance services. Some dealers may be authorized service centers for those OEMs whose products are warranted separately and excluded from the **Limited Warranty**.

SECTION 1: WARRANTY & SERVICE

OBTAINING SERVICE AT OUR CUSTOMER SERVICE FACILITY

Should your recreation vehicle be in need of service, and your dealer recommends that the repairs be made at our Customer Service facility, your recreation vehicle may be returned to us with the following guidelines*:

- You or your dealer must make a confirmed appointment 60 days prior to dropping off the recreation vehicle at our Customer Service facility.
- The holding tanks must be emptied and rinsed. We have a dumping station available for customer use.
- The propane system (if so equipped) and all electrical systems must be shut down and turned off. We are not responsible for discharged batteries or propane tanks.
- During the appropriate season, please ensure the RV has been winterized.
- Unless prior approval has been obtained from our Customer Service facility, all personal items must be removed from the area where you are requesting service repair and the refrigerator emptied. We are not responsible for loss of food items.
- All transportation costs are the responsibility of the owner. You may need to arrange for alternative accommodations for some types of repairs. Please be prepared accordingly.

**Our Customer Service facility occasionally utilizes local independent repair facilities. Your vehicle may be referred to or repaired by one of these local repair facilities.*

PARTS AND ACCESSORIES

Contact your authorized dealer for assistance in obtaining replacement parts or accessories. We do not sell direct to retail or non-authorized dealers. If the original part is no longer available, we will make every effort to provide an appropriate substitute.

JAYCO MOTORIZED LIMITED WARRANTY

THIS LIMITED WARRANTY COVERS:

- The Motorhome when it is used only for its intended purpose of recreational travel and camping;
- Only the first retail purchaser;
- Only those portions of the Motorhome not excluded under the section “What is Not Covered”;
- The Motorhome only when sold by an authorized dealership; and,
- Only defects in workmanship performed and/or materials used to assemble those portions of the Motorhome not excluded under the section “What is Not Covered”.
- This Limited Warranty is not transferable.

When you request and accept the performance of warranty repairs under the terms of this Limited Warranty, you are accepting all terms of this Limited Warranty, including by way of example, warranty limitations and disclaimers, the forum selection clause and the clause reducing the time period when suit must be filed for breach.

LIMITATION AND DISCLAIMER OF IMPLIED WARRANTIES:

THE DURATION OF ANY IMPLIED WARRANTY IS LIMITED TO:

- **THE DURATION OF THIS LIMITED WARRANTY;**
- **THE SCOPE OF COVERAGE THIS LIMITED WARRANTY PROVIDES;**
- **DEFECTS EXISTING AT THE TIME OF SALE THAT MANIFESTED THEMSELVES AND SURFACED DURING THE IMPLIED WARRANTY COVERAGE PERIOD; AND**
- **DEFECTS DISCOVERED AND REPORTED WITHIN THE DURATION OF THE IMPLIED WARRANTY. THERE ARE NO EXPRESS WARRANTIES OR ANY IMPLIED WARRANTIES ON THOSE PORTIONS OF THE MOTORHOME EXCLUDED FROM COVERAGE.**

NOTWITHSTANDING THE ABOVE PROVISIONS, JAYCO EXPRESSLY DISCLAIMS AND EXCLUDES ANY AND ALL IMPLIED WARRANTIES AND CONDITIONS, STATUTORY OR OTHERWISE, WHEN THE MOTORHOME IS USED FOR COMMERCIAL, RENTAL OR BUSINESS USE OR WHEN THE MOTORHOME IS TITLED OR REGISTERED IN A BUSINESS NAME OR WHEN THE JAYCO IS SOLD IN CANADA.

There is no warranty of any nature made by Jayco beyond that contained in this Limited Warranty. No person has authority to enlarge, amend or modify this Limited Warranty. The dealer is NOT Jayco’s agent. Jayco is not responsible for any undertaking, representation or warranty made by any dealer or others beyond those expressly set forth within this Limited Warranty. Some states and provinces do not allow limitations on how long an implied warranty lasts, so the above limitation may not apply to you.

SECTION 1: WARRANTY & SERVICE

DISCLAIMER OF CONSEQUENTIAL AND INCIDENTAL DAMAGES:

THE FIRST RETAIL BUYER AND ANY SUBSEQUENT OWNER, ALONG WITH ANY PERSON WHO IS AN INTENDED OR UNINTENDED USER OR BENEFICIARY OF THE MOTORHOME, ARE NOT ENTITLED TO RECOVER ANY CONSEQUENTIAL OR INCIDENTAL DAMAGES CAUSED BY A DEFECT IN THE MOTORHOME. BY WAY OF EXAMPLE, CONSEQUENTIAL DAMAGES INCLUDE FUEL AND TRANSPORTATION EXPENSES TO DELIVER THE MOTORHOME TO A SERVICING DEALER, HOTEL ROOMS, LOST WAGES AND MOISTURE DAMAGE SUCH AS MOLD AND MILDEW AS WELL AS RUST AND CORROSION. THE EXCLUSION OF CONSEQUENTIAL AND INCIDENTAL DAMAGES ARE NOT DEPENDENT UPON WARRANTY REMEDIES SUCCESSFULLY CURING ANY DEFECT; THE EXCLUSION OF CONSEQUENTIAL AND INCIDENTAL DAMAGES SHALL SURVIVE ANY FAILURE OF THE LIMITED WARRANTY REMEDIES FULFILLING THEIR PURPOSE. Some states do not allow the exclusion or limitation of consequential or incidental damages, so the above exclusions may not apply to you.

COVERAGE TIME: The duration of this limited warranty is 2 years after the first retail owner takes delivery of the Motorhome from an authorized dealer **OR** 24,000 miles of use, whichever occurs first. If the dealer places the Motorhome in service before retail sale, the coverage period is 2 years after the dealer first placed the Motorhome in service **OR** 24,000 miles of use, whichever occurs first. **ANY ACTION FOR BREACH OF THIS LIMITED WARRANTY OR FOR ANY IMPLIED WARRANTY MUST BE COMMENCED NO MORE THAN 26 MONTHS AFTER THE BREACH.**

The term of this limited warranty is 3 years for substantial defects to any “Structure Components”. Structure Components means materials and/or workmanship directly attributable to Jayco relating to the laminated fiberglass sidewall assembly, laminated rear wall assembly, laminated fiberglass front wall (wrap) assembly, sidewall/end wall/front and rear wall frame assembly (wood and aluminum), roof assembly, and floor assembly. Structure Components specifically excludes front and rear fiberglass caps and any other cosmetic fiberglass attachments, sidewall metal (unless the root cause is the wall structure); exterior roof material (EPDM rubber, TPO, etc.); floor covering (carpet, linoleum, hardwood tile, etc.); all sidewall, end wall, front and rear wall, roof and floor attachments, and delamination caused by water intrusion from lack of required exterior seal maintenance or other maintenance. Structure Components further excludes all items identified under “What is Not Covered” below.

Jayco reserves the right to have new or remanufactured parts of similar quality used to complete any work, and to make parts and design changes from time to time without notice to anyone. Jayco reserves the right to make changes in the design or material of its products without incurring any obligation to incorporate such changes in any product previously manufactured. Jayco makes no warranty as to the future performance of the Motorhome, and this limited warranty is not intended to extend to the future performance of the Motorhome, or any of its materials, components or parts. In addition, the Motorhome owner’s obligation to notify Jayco, or one of its independent, authorized dealers, of a claimed defect does not modify any obligation placed on the Motorhome owner to contact Jayco directly when attempting to pursue remedies under state or federal law.

SECTION 1: WARRANTY & SERVICE

If the Motorhome is not of the current or prior model year when the first retail owner takes delivery, the limited warranty, including but not limited to the limited warranty for substantial defects to Structure Components, ends 90 days after the first retail owner takes delivery of the Motorhome **OR** after the odometer reaches 5,000 miles, whichever occurs first. **ANY ACTION FOR BREACH OF THIS REDUCED LIMITED WARRANTY OR FOR ANY IMPLIED WARRANTY MUST BE COMMENCED NO MORE THAN 15 MONTHS AFTER THE BREACH.**

Unless prohibited by state or provincial law, repairs do not extend the time when you must commence an action for breach of warranty and shall not extend the warranty coverage period. This reduction in time may not apply to you because some states and provinces do not allow the reduction of the time to commence an action for breach of warranty. Any performance of repairs after the warranty coverage ends and any performance of repairs to those portions of your Motorhome excluded from coverage are “good will” repairs, whether or not Jayco was aware of the any such coverage lapse or warranty exclusion at the time of repairs. Such “good will” repairs do not alter the express terms of this limited warranty or extend the warranty coverage periods or the limitation period in this paragraph. Jayco is not required to notify you if authorized repairs are considered “good will” by Jayco. You should expect the need for warranty repairs. Jayco may use new and/or remanufactured parts and/or components to complete a repair. It is likely that warranty repairs were performed at the factory during assembly **OR** at the selling dealership after delivery of the Motorhome to your selling dealer. If you discover a defect or damage to the Motorhome when you take delivery of your Motorhome, you **MUST** notify your dealer **OR** Jayco within 10 days of the date of purchase to have defect or damage repaired at no cost to you. Minor adjustments will be performed, free of charge, by the dealer within 90 days of your purchase; thereafter, such adjustments are your exclusive responsibility as normal maintenance.

REPAIR REMEDY: Jayco’s obligation is to repair any covered defect discovered within the warranty coverage period provided: (1) you notify Jayco or an authorized dealer within 10 days of your discovery of a defect; **AND** (2) you deliver the Motorhome to Jayco **OR** an authorized dealership at your cost and expense.

BACK-UP REMEDY: If the primary repair remedy fails to successfully cure any defect after a reasonable number of repair attempts, your sole and exclusive remedy shall be to have Jayco pay an independent service shop of your choice to perform repairs to the defect **OR** have Jayco pay diminished value damages if the defect is incurable. You must exhaust both the repair remedy and the back-up remedy **AND** these remedies must fail to fulfill their essential purpose before you can seek any other remedies.

THIS LIMITED WARRANTY IS NOT A WARRANTY THAT PROMISES OR EXTENDS TO FUTURE PERFORMANCE BECAUSE IT DOES NOT MAKE A REPRESENTATION ON HOW YOUR MOTORHOME WILL PERFORM IN THE FUTURE BUT REPRESENTS ONLY WHAT THE REMEDY WILL BE IF A DEFECT EXISTS.

HOW TO GET SERVICE: To obtain warranty service the owner must:

- Notify Jayco or an authorized Jayco dealer, within the applicable warranty coverage period designated above, that you are making a warranty claim;
- Provide the notification mentioned in (1), above, within ten (10) days of the discovery of a defect in material or workmanship; and,
- Promptly schedule an appointment with and take the Motorhome to Jayco or an independent, authorized dealer.

If you need assistance, you may contact JAYCO, INC. at 903 South Main Street, P. O. Box 460, Middlebury, Indiana 46540, Attn: Customer Service, (800) 517-9137.

SECTION 1: WARRANTY & SERVICE

WHAT IS NOT COVERED:

- Equipment and appliances installed after the Motorhome is assembled by Jayco;
- Motorhomes used for any rental, business and commercial purpose - If the Motorhome owner or user files a tax form claiming a business or commercial tax benefit related to the Motorhome, or if the RV is purchased, registered or titled in the name of any business association it shall be irrefutable that the Motorhome has been used for rental, commercial or business purposes;
- Any Motorhome sold or used outside of the United States, U.S. Territories or Canada;
- Any Motorhome not used solely for recreational travel and camping;
- Any Motorhome purchased through auction or wholesale;
- Any Motorhome purchased from a dealer that is not an authorized dealer;
- Normal wear, tear or usage, such as tears, punctures, soiling, mildew, rust, fading, or discoloration of exterior plastic or fiberglass, or soft goods, such as upholstery, drapes, carpet, vinyl, screens, cushions, mattresses and fabrics;
- The effects and damage caused by condensation or moisture;
- Mold;
- Any damage caused by mold;
- Items working as designed but that you are unhappy with;
- Damage caused by misuse, mishandling, neglect, abuse, failure to maintain the Motorhome in accordance with the owner's manual, or failure to perform other routine maintenance such as inspections, lubricating, adjustments, tightening of screws and fittings, tightening of lug nuts, sealing, rotating tires;
- Damage caused by accident, whether or not foreseeable;
- Damage caused by weather or corrosion due to the environment;
- Damage caused by theft, vandalism or fire;
- Damage caused by tire wear or tire failure;
- Defacing, scratches, dents, chips on any surface or fabric of the Motorhome; damage caused by infestation by insects or animals;
- Damage caused by off road use;
- Damage caused by overloading the Motorhome or any of its components or parts;
- Wheel alignment or adjustments to axles caused by improper maintenance, loading;
- Damage caused by road hazards;
- The leveling jacks/system;
- Any component, system or part warranted by another entity. Examples are : the automotive chassis, (including the power train, steering, handling, braking, wheel balance, muffler, tires, tubes, batteries and gauges); generator; awning ; inverter; converter; microwave; television; DVD/CD player; radio; speakers; television; refrigerator; range; water heater; water pump; stove; carbon monoxide detector; smoke detector; propane detector; furnace; and, any air conditioner. The written warranty provided by the manufacturer of the component part is the direct and exclusive responsibility of that manufacturer).

EVENTS DISCHARGING JAYCO FROM OBLIGATION UNDER WARRANTY:

- Any rental, business or commercial use or purchase of the Motorhome;
- Any Motorhome titled or registered in a business name;
- Any Motorhome purchased or sold outside of, or used outside of the United States, U.S. Territories or Canada;
- Any Motorhome purchased through an auction or wholesale or by a non-authorized dealer;
- Owner neglect;
- Failure to provide routine maintenance;
- Alteration; off road use;
- Collision or accident, whether or not foreseeable;
- Acts of God, including weather;
- Damage or corrosion caused by the environment, theft, vandalism, fire, explosions, or overloading.

LEGAL REMEDIES: EXCLUSIVE JURISDICTION FOR DECIDING LEGAL DISPUTES RELATING TO AN ALLEGED BREACH OF WARRANTY OR ANY REPRESENTATIONS OF ANY NATURE, MUST BE FILED IN THE COURTS WITHIN THE STATE OF MANUFACTURE, WHICH IS INDIANA. THIS LIMITED WARRANTY SHALL BE INTERPRETED AND CONSTRUED IN ACCORDANCE WITH THE LAWS OF THE STATE OF INDIANA. UNLESS PROHIBITED BY STATE LAW, ALL CLAIMS, CONTROVERSIES AND CAUSES OF ACTION ARISING OUT OF OR RELATING TO THIS LIMITED WARRANTY SHALL BE GOVERNED BY THE LAWS OF THE STATE OF INDIANA, INCLUDING ITS STATUTE OF LIMITATIONS, WITHOUT GIVING EFFECT TO ANY CONFLICT OF LAW RULE THAT WOULD RESULT IN THE APPLICATION OF THE LAWS OF A DIFFERENT JURISDICTION.

THIS WARRANTY GIVES YOU SPECIFIC LEGAL RIGHTS. YOU MAY ALSO HAVE OTHER RIGHTS, WHICH VARY FROM STATE TO STATE AND PROVINCE TO PROVINCE. ALL ACTIONS OF ANY KIND RELATING TO THE MOTORHOME SHALL BE DECIDED BY A JUDGE RATHER THAN BY A JURY.

WARRANTY REGISTRATIONS: Your warranty registrations should be completed and delivered to the manufacturer of component parts. The selling dealership will assist you in completing and filling out the Jayco product warranty registration. Upon receipt of the product registration by Jayco, your Warranty will be registered. The failure to submit this warranty registration to Jayco will not affect your rights under this limited warranty as long as you can present proof of purchase, however, it can cause delays in obtaining the remedies offered by this limited warranty, and it may adversely affect any servicing facility's ability to provide proper repairs and/or part replacement. Note, tender and acceptance of a warranty registration does not alter the express terms of this limited warranty or any of its exclusions.

CARE AND MAINTENANCE: It is the Owner's responsibility to perform proper care and maintenance of the Motorhome and to assure correct load distribution. For details regarding this, please see your owner's manuals. Please review all manuals and contact your selling dealership, Jayco or supplier of the component part if you have questions.

SECTION 1: WARRANTY & SERVICE

THIS WARRANTY GIVES YOU SPECIFIC LEGAL RIGHTS; YOU MAY HAVE OTHER RIGHTS THAT VARY FROM STATE TO STATE.

JAYCO, INC.

903 S. Main Street * P. O. Box 460 * Middlebury, IN 46540
Telephone: 800-517-9137

SECONDARY MEANS OF ESCAPE (EXIT WINDOW)

Your recreation vehicle has been equipped with a window(s) that serves as a secondary means of escape. The window(s) will allow a quick exit from the vehicle during an emergency if access to the main entrance door is not available. It is easily identified by the red latches and label.

Do not remove the EXIT window label from your RV:

When parking your recreation vehicle, make sure the egress window is not blocked by trees or other obstacles. Make sure the ground below the window is solid and can be used as an escape path.



Exit Window Label

Practice opening the window before an emergency occurs, and make sure all occupants know how to operate it.

 CAUTION
Exercise care when opening the exit window. If opened too far, it may come off the hinge. This may result in damage to the unit or window.



NOTE: All windows must be closed and locked while the RV is in transit.

Your recreation vehicle may be equipped with one of the following exit window styles:

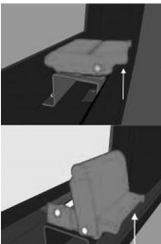

Flip latch style (2 per window)

Push up on the front lip of the latch and the latch unfolds.
Push up on the front lip of the latch again to unhook the latch from the window.
When both latches are released, push out on the window which is hinged at the top. Exit the vehicle.
The screen does not need to be removed from the window.

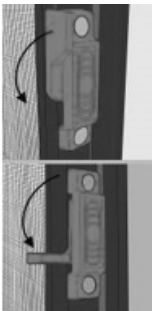

Slider window latch style

Pull the lever down to unlock the window.
Slide the window to the right to open and exit the vehicle.
The screen does not need to be removed from the window.

SECTION 2: OCCUPANT SAFETY

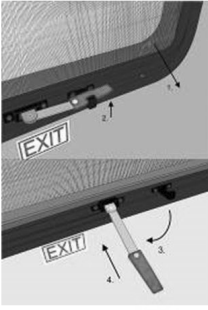

Lever style latch

Remove the screen by pulling the red tab (upper right arrow).

Pull the lever out from the sash clamps.

Swing the lever out so it is positioned straight out from the window. Push the lever (and window) out to open and exit the vehicle.

FIRE SAFETY

If a fire does start, follow these basic safety rules:

1. Call 911 and evacuate the vehicle immediately.
2. After everyone is accounted for, check the fire to see if you can attempt to put it out.
3. If it is large, or the fire is fuel-fed, get clear of the vehicle and have the Fire Department handle the emergency.
4. Do not attempt to use water to put out the fire. Water can spread some types of fire, and electrocution is possible with an electrical fire.

Refer to the following sections for additional fire safety information.

- **Electrical Systems**, In case of an electrical fire.
- **Appliances**, In case of a grease fire.

FIRE EXTINGUISHER

Fire extinguishers are classified and rated by fire type, A, B and C. These classifications identify the kinds of fires or burning materials they are designed to fight.

Class A - Solid materials such as wood, paper, cloth, rubber and some plastics.

Class B - Liquids such as grease, cooking oils, gasoline, kerosene or other flammable liquids.

Class C - Electrical such as electrical wires or other live electrical equipment.

A dry chemical fire extinguisher has been installed by the entrance door. It is suitable for extinguishing small fires of the Class B or C type only.

We suggest you become thoroughly familiar with the operating instructions displayed on the side of the fire extinguisher.



NOTE: For information on how to use your fire extinguisher, refer to the fire extinguisher user's manual

Inspection and maintenance

Read and follow all instructions on the label and user's manual provided by the fire extinguisher manufacturer.

- Inspect the extinguisher at least once a week (more frequently if it is exposed to weather or possible tampering). This should also be done before beginning a vacation or during an extended trip.

 WARNING

Do not check the pressure, test or practice using the fire extinguisher by squeezing the trigger, even briefly. The fire extinguisher is not rechargeable or refillable. Once used, it will gradually lose pressure and will not be fully charged for use in an emergency.

 DANGER

Do not turn the electrical power back on or plug in any appliances after the use of a fire extinguisher. Please refer to the fire extinguisher's user manual for further instructions on maintenance and clean up.

SMOKE ALARM

The smoke alarm will only work properly if it is operational and maintained. They have a limited life and will wear out over time. Immediately replace the detector if it is not working properly, if it displays any type of problem, or within five years of use. **Be sure to read, understand and follow the information provided by the smoke alarm manufacturer, including information on the limited life of smoke alarms.**

Be aware the smoke alarm **is not fool proof and cannot detect fires if smoke does not reach it**. Anything preventing smoke from reaching the alarm may delay or prevent an alarm.

Though the alarm horn in this detector meets or exceeds current UL standards, it may not be heard for reasons that include (but not limited to): a closed or partially closed door, other noise from electronics, appliances or traffic.

 WARNING

- This smoke alarm will not alert hearing impaired residents. Special alarms with flashing strobe lights are recommended for the hearing impaired
- Only use the replacement battery recommended by the smoke detector manufacturer. The smoke detector alarm may not operate properly with other batteries. Never use a rechargeable battery as it may not provide a constant charge. Never disconnect the battery to silence the alarm.
- Test the smoke alarm operation after the vehicle has been in storage, before each trip and at least once per week during use. Do not disconnect the battery or the alarm.

The smoke alarm is operational once the battery is correctly installed. It will not function if the battery is missing, disconnected, dead, the wrong type or not installed correctly. **It requires one standard 9V battery.** Refer to the user's guide, for correct battery and installation information,

The LED light will indicate the battery is functioning properly. When the production of combustion is sensed, the smoke detector sounds a loud alarm that continues until the air is cleared. The LED light will also give a visual indication of a sounding alarm.

SECTION 2: OCCUPANT SAFETY

When the battery becomes weak, the alarm will “beep” about once a minute indicating a low battery. This warning should last for 30 days. You **MUST** replace the battery once the alarms low battery warning (beep) starts to assure continued protection.

When the battery is removed from the alarm, the battery flag will pop up; the alarm cannot be installed to the mounting bracket without a battery.

To test, stand at arm’s length from the smoke alarm as the alarm horn is loud and may be harmful to your hearing. The test button will accurately test all functions. Never use an open flame to test the smoke alarm.

Do not remove the warning label located near the smoke alarm from your recreation vehicle:

Maintenance

Vacuum off any dust on the cover of the smoke alarm using a soft brush attachment. Test the smoke alarm once you have vacuumed. Never use water, cleaners or solvents to clean the smoke alarm as they may damage the alarm. Do not paint the smoke alarm. Refer to the manufacturer’s use guide for detailed maintenance information.

<p>▲ WARNING</p> <p>Test smoke alarm operation after vehicle has been in storage, before each trip, and at least once per week during use. Failure to do so can result in death or serious injury.</p>
<p>▲ AVERTISSEMENT</p> <p>VÉRIFIER LE DÉTECTEUR DE FUMÉE SI LE VÉHICULE A ÉTÉ ENTREPOSÉ, AVANT CHAQUE DÉPLACEMENT ET AU MOINS UNE FOIS PAR SEMAINE EN SERVICE.</p>

COMBINATION CARBON MONOXIDE / PROPANE ALARM

Your recreation vehicle is equipped with a combination carbon monoxide (CO) / propane alarm that is listed for use in recreation vehicles. The combination carbon monoxide/propane alarm will only work if it is operational and maintained.

<p>▲ WARNING</p> <ul style="list-style-type: none"><input type="checkbox"/> The carbon monoxide detector installed is intended for use in ordinary indoor locations of recreation vehicles. It is not designed to comply with Occupational Safety and Health Administration (OSHA) commercial or industrial standards.<input type="checkbox"/> Do not disconnect the battery or the alarm.<input type="checkbox"/> Individuals with medical problems may consider using warning devices that provide audible and visual signals for carbon monoxide concentrations under 30 PPM.<input type="checkbox"/> This alarm will only indicate the presence of carbon monoxide gas at the sensor. Carbon monoxide gas may be present in other areas.<input type="checkbox"/> The ultimate responsibility for protection against toxic carbon monoxide fumes rests solely on you. Installing a carbon monoxide/propane alarm is just the first step in protecting your family from toxic carbon monoxide poisoning. The following symptoms are related to carbon monoxide poisoning and should be discussed with all members of the household:<input type="checkbox"/> Mild exposure: Slight headache, nausea, vomiting, fatigue (often described as “flu-like” symptoms).<input type="checkbox"/> Medium exposure: Severe throbbing headaches, drowsiness, confusion, fast heart rate.<input type="checkbox"/> Extreme exposure: Unconsciousness, convulsions, cardio-respiratory failure, death.

The alarm is directly wired to the 12-volt electrical system, with continuous power being supplied by the recreational vehicle batteries. There is no 9-volt battery power supply. As a result, the alarm is always drawing a small amount of current from the recreation vehicle batteries. Although the current draw is slight, it could drain the batteries during extended storage periods. This condition is not likely to occur except during storage situations when the inverter cannot restore the battery charge. **If the battery cable is disconnected at the battery terminals, the combination alarm will not work.**

Be sure to read, understand and follow the owner's information from the manufacturer of the combination CO/propane alarm. This includes information regarding the limited life of the alarm.

Carbon monoxide (CO) is an insidious poison. It is a colorless, odorless and tasteless gas. Many cases of reported carbon monoxide poisoning indicate while victims are aware they are not well, they become so disoriented they are unable to save themselves by either exiting the recreational vehicle or calling for assistance. Young children and household pets may be the first affected.

Your combination carbon monoxide/propane alarm is designed to detect the toxic carbon monoxide fumes that result from incomplete combustion, such as those emitted from appliances, furnaces, fireplaces and auto exhaust.

A carbon monoxide/propane alarm is **NOT A SUBSTITUTE** for other combustible gas, fire or smoke alarms. This carbon monoxide alarm is designed to detect carbon monoxide gas from ANY source of combustion. It is not designed to detect smoke, fire or any other gas. Please note that there are hazards against which carbon monoxide detection may not be effective, such as natural gas leaks or explosions.

This alarm is designed to sense the presence of carbon monoxide/propane gas, however there are other combustible fumes or vapors that may be detected by the sensor including (but not limited to): acetone, alcohol, butane and gasoline.

These chemicals can be found in commonly used items such as deodorants, colognes, perfumes, adhesives, lacquer, kerosene, glues, wine, liquor, most cleaning agents and the propellants of aerosol cans.

High temperatures can activate glue and adhesive vapors. If you close up a recreational vehicle on a hot day, the chemicals used in its construction may be detected for months after the vehicle was constructed (for more information, refer to Sec. 2, Formaldehyde).



Carbon monoxide/propane alarm (alarm may vary from model(s) shown)

SECTION 2: OCCUPANT SAFETY

What you should do if the alarm sounds

WARNING

- Actuation of this detector indicates the presence of carbon monoxide which can kill you.
- Never turn the 12-volt battery disconnect control to the off position and disconnect the battery cable to silence an alarm. The alarm will automatically sense when the level of carbon monoxide in the air reaches below dangerous levels. You should stay outside the vehicle in fresh air until the alarm is silenced. When the alarm sounds, do not stand too close to the alarm. The sound produced by the alarm is loud because it is designed to wake a person in an emergency. Prolonged exposure to the alarm at a close distance may be harmful to your hearing.

1. Operate the RESET/SILENCE button.
2. Call your emergency services (fire department or 911).
3. Immediately move to fresh air (outdoors or by an open door or window).
4. Do not re-enter the premises or move away from the open door or window until the emergency service responders have arrived, the premises have been aired out, and your alarm remains in its normal condition.

If your alarm reactivates within a 24 hour period, repeat steps 1-4 and call a qualified appliance technician to investigate for sources of carbon monoxide from fuel burning equipment and appliances, and inspect for proper operation of this equipment. Make sure that motor vehicle(s) are not, and have not been, operating in an attached garage or adjacent to the recreation vehicle.

If problems are identified during this inspection, have the alarm serviced immediately. Note any combustion equipment not inspected by the technician and consult the manufacturer's instructions or contact the manufacturer directly for more information about carbon monoxide safety and this alarm.

Alarm signals

- Normal operation:** The LED will maintain a steady green light, indicating that the alarm is powered.
- CO alarm condition:** The red LED light will remain steady and the alarm will sound 4 "BEEPS" then silent for 5 seconds. These signals indicate immediate action is required.
- Propane gas alarm:** The red LED flash and the alarm will sound a steady tone. These signals indicate immediate action is required.
- Alarm malfunction/low battery:** The gas LED will remain off and the Operational/CO LED will alternate red/green and the alarm will sound once every 15 seconds.
- End of life alarm:** The LED will flash red/red, green/green and the alarm will "BEEP" every 25-30 seconds. The alarm should be immediately replaced.

Maintenance

Vacuum the alarm cover at least once a year. Clean the cover by hand using a cloth dampened in clean water. Dry with a soft cloth. Do not spray the front panel of the alarm with cleaning agents or waxes. This action may damage the sensor causing an alarm or cause the alarm to malfunction. Do not paint the face of the alarm.

Testing the combination carbon monoxide/propane alarm

 WARNING

Test the alarm operation after the motorhome has been in storage, before each trip and at least once per week during use.

The TEST/RESET button tests all ELECTRICAL functions of the alarm. The TEST/Mute switch is located on the front of the alarm. Press and hold the test button for 1 second. The alarm is working properly if the GREEN indicator light changes color to RED and the horn beeps 4 times. The Gas LED should also blink red.

 **NOTE:** Pressing the test button does not check the sensor operation. Refer to the carbon monoxide/propane alarm manufacturers user's manual provided with your recreation vehicle for additional information on testing the sensors.

Repair or replace the combination carbon monoxide/propane alarm when the alarm no longer functions. As with any electronic product, it has a limited life. Alarms that do not work cannot protect you.

 **NOTE:** The carbon monoxide/propane alarm manufacturer strongly recommends replacement of the detector five years after the date of purchase.

FORMALDEHYDE

Some components in the recreation vehicle contain formaldehyde-based adhesives that may release formaldehyde fumes into the air for an unknown period of time. Individuals who are allergic to formaldehyde gas fumes may experience irritation to eyes, ears, nose and throat. Indoor air quality may also be affected by leaving your vehicle closed for a period of time.

To aid in dissipation, ventilate the recreation vehicle by opening all windows and circulate the air with a fan.

This label is located inside the vehicle near the entry door. **The label should be left permanently affixed to the recreation vehicle.**

 CAUTION

Product in this vehicle may contain formaldehyde, which may be an irritant to you. You may experience a greater concentration during high humidity and temperatures. Ventilate to remove. Consult your owner's manual for additional information.

DO NOT REMOVE THIS LABEL

SECTION 2: OCCUPANT SAFETY

EXTENDED OR FULL TIME USAGE

Your new recreation vehicle has been built for enjoyment in a recreational manner. It is not intended for use as full-time quarters or a permanent residence. Continuous living in your vehicle could cause accelerated wear and damage to the various components.



CAUTION

Continuous or permanent living in your recreation vehicle may affect your warranty coverage and may void the “Limited Warranty” applicable to your vehicle.

COLD WEATHER USAGE

When used in freezing or below freezing temperatures, the precautions should be taken:

- Fresh water and drainage systems - preparations to avoid freeze-ups.
- Propane gas (if so equipped) and sufficient power is needed for protection from possible freeze-ups on the propane gas regulator. Keep in mind that more frequent furnace operation will substantially increase battery draw and propane gas use.
- During cool weather usage, ventilation or addition of a dehumidifier may be required to reduce condensation.
- Check outside extrusions on compartment doors, locks, slide outs, windows, vents, etc., for frozen moisture before operating to avoid damage to parts.

CONDENSATION



WARNING

Condensation may cause dampness, mildew, mold, staining and, if allowed to continue, it may result in damage to the recreation vehicle (damage caused by condensation is not warrantable). It can also lead to mold or mildew issues, which could be a health hazard.

Condensation is a natural phenomenon. The amount of condensation will vary with climate conditions, particularly the relative humidity. Condensation occurs because there is water vapor present in the air. When the temperature reaches the “dew point” the water vapor in the air condenses and changes to a liquid form.

Proper ventilation or the use of a dehumidifier (customer supplied) will assist in controlling the condensation. Suggestions to eliminate warm moist air:

- Crack open windows and roof vents to allow warm moist air to escape.
- Open the bath roof vent (if so equipped) approximately ½” when showering.
- Use the range hood fan (if so equipped) when cooking or washing dishes.
- Avoid hanging wet towels (or clothes) inside the recreation vehicle to dry.
- If found in cabinets or closets, open the doors slightly to provide ventilation.

VEHICLE LABELS

Decals and data plates used throughout the motorhome aid in its safe and efficient operation; others give service instructions. Read all decals, data and instruction plates before operating your recreation vehicle. Any decal, data or instruction plate painted over, damaged or removed should be replaced.

Keep a record of the 17-digit chassis vehicle identification number (VIN), the 9-digit serial number, and your license number in the event theft or vandalism requires you to supply this information to the authorities.

 WARNING
<ul style="list-style-type: none"><input type="checkbox"/> The factory-installed weight labels are specific to the recreation vehicle for which they are supplied and are not interchangeable. Do not remove these labels from your vehicle. If labels are missing contact your dealer or Customer Service for replacements.<input type="checkbox"/> Do not exceed any applicable motorhome weight ratings. Doing so could damage your motorhome or affect handling and braking characteristics.<input type="checkbox"/> Your motorhome braking system is designed and rated for operation at GVWR not GCWR.

Weight Terms

GAWR - Gross Axle Weight Rating: The value specified by the vehicle manufacturer as the load-carrying capacity of a single axle system, as measured at the tire-to-ground interfaces. This is the total weight a given axle is capable of carrying.

GCWR - Gross Combined Weight Rating: The value specified by the motorhome manufacturer as the maximum allowable loaded weight of the motorhome in combination with its towed trailer or towed vehicle. The tongue weight of a towed vehicle/ trailer counts as part of the motorhome cargo.

GVWR - Gross Vehicle Weight Rating: The value specified by the manufacturer as the maximum permissible weight of the fully loaded motorhome.

OCCC - Occupant and Cargo Carrying Capacity: Is equal to the GVWR of the motorhome, minus the weight of the motorhome, as completed at the factory, minus the weight of all occupants, including the driver, minus the weight of all personal cargo, minus the weight of a full tank of chassis engine fuel and, if applicable, minus the weight of a full tank of propane. The full weight of potable water, including the water heater and the tongue weight of a towed vehicle/ trailer counts as cargo in or on the motorhome. Additions to or other changes made to the motorhome after it left the factory will affect (reduce) the OCCC.

UVW - Unloaded Vehicle Weight: The weight of this motorhome as manufactured at the factory with fuel, engine oil and coolants and if applicable, the weight of a full tank of propane.

SECTION 3: PRE-TRAVEL INFORMATION

Weight and Capacity Labels

The following labels are located on the inward-facing surface of the main entry door of the motorhome and on the lower sidewall left of the driver's seat.

OCCC Label (Occupant and Cargo Carrying Capacity): The upper portion of this yellow label is federally required and indicates the total combined weight value of occupants and cargo that may be placed in or on your motorhome as it was manufactured and weighed before leaving the factory.

This label also indicates the number of safety seat belts that have been installed at the factory. Additions or other changes made to the motorhome after it left the factory will affect (reduce) the OCCC.

The lower portion of the label is provided voluntarily and indicates the weight value of the motorhome as it was manufactured and weighed before leaving the factory. This label also indicates the GCWR of the completed motorhome.

The **Federal Certification Label** is required by the government to verify the RV complies with all motor vehicle standards for Canada and the United States. It includes the following information: Manufacturer name, VIN, GVWR, GAWR (front/rear), tire and rim sizes and cold tire inflation pressures.

The **motorhome towing and braking label** is located on the rear bumper above the hitch receiver. Be sure to read and follow the guidelines and information stated on this label. Refer to the Chassis Guide for additional information.

MOTOR HOME OCCUPANT AND CARGO CARRYING CAPACITY
 VIN: XXXXXXXXXXXXXXXXXXXXX
 THE COMBINED WEIGHT OF OCCUPANTS AND CARGO SHOULD NEVER EXCEED:
 XXXX kg. OR (XXXX Lbs.)
 SAFETY BELT EQUIPPED SEATING CAPACITY: X
 CAUTION:
 A FULL LOAD OF WATER EQUALS XXXX kg. OR (XXX Lbs.) OF CARGO @ 1 kg/L (8.3 Lb/gal)
 AND THE TONGUE WEIGHT OF A TOWED TRAILER COUNTS AS CARGO

Upper Section Federal OCCC Weight Label

THE WEIGHT OF THIS RECREATIONAL VEHICLE MOTOR HOME AS COMPLETED AT THE FACTORY WITH FULL PROPANE TANK AND FULL ENGINE FUEL IS:

XXXXX kg. OR (XXXXX Lbs.)

THE GCWR OF THIS RECREATION VEHICLE MOTOR HOME IS: XXXXX kg OR (XXXXX Lbs)

CONSULT YOUR DEALER AND SEE OWNER'S MANUAL FOR DEFINITIONS, ADDITIONAL WEIGHT, LOADING, WEIGHING INFORMATION AND TOWING GUIDELINES INCLUDING AUXILIARY BRAKE REQUIREMENTS FOR ANY TOWED TRAILER OR VEHICLE.

Lower Section Federal OCCC Weight Label

DEP. NBR:	EJLJULY		08/11
FABRICANT REP:			PRES./OLD INFL.
GAWR/FRE KG	9950	4517	PRES./GROSS PROD
	5225/3098/5030		
GAWR/FRE KG	TIRE/PRES	RIMS/ANTE	PUL/F.C. SPA
5000	220/2.F/90/10EVANT	07225/25R150	16. X 8. JJ
5000L/REV/RENTAL			0680
5000	220	REAR/ARRIERE	07225/25R150/16. X 8. JJ
			06
			0680
TYPE OF VEHICLE/TYPE DE VEHICULE:		TRAILER/REMORQUE	
THE FOLLOWING INFORMATION APPLIES TO:		IS FINANCIAL SERVICE FINANCING AVAILABLE?	
TOTAL RETAIL PRICE (GROSS WEIGHT AND CARGO) INCLUDING TAXES AND FEES:		IS FINANCING AVAILABLE IN YOUR PROVINCE?	
NEW VEHICLES MUST INCLUDE A COPY OF THIS LABEL IN THE DATE OF MANUFACTURE AND BE AVAILABLE TO THE USER FOR THE LIFE OF THE VEHICLE'S USE.		IS FINANCING AVAILABLE IN YOUR PROVINCE?	

Federal Certification Label

▲ WARNING

The braking capacity of your motor home is not necessarily as great as its towing capacity. Separate braking systems should be used for control of a towed vehicle, (auto, trailer, boat etc.), behind the motor home. Braking requirements will vary by chassis type, chassis manufacturer and state law. Contact your chassis dealer or independent RV dealer for assistance to determine if a separate braking system is recommended and what limit(s) may apply for your towing combination and traveling safety.

The use of a reducing sleeve and smaller diameter draw bar or a longer draw bar in and on the hitch receiver will reduce the hitch weight rating and towing capacity. Use of a draw bar longer than 18-inches (457mm) is prohibited.

Consult your vehicle owner's manual(s) and your independent RV dealer for specific weighing instructions and towing guidelines.

Improper use of towing equipment and towing setups can cause loss of control that may lead to an accident resulting in death or serious injury.

Towing and Braking Warning Label

For more information: Consult a hitch specialist or your dealer for assistance when preparing your motorhome for towing a vehicle or trailer.

LOADING YOUR MOTORHOME

⚠ WARNING

- **Never load the motorhome in excess of the GVWR or the GAWR for either axle. Overloading your motorhome may result in adverse handling characteristics and damage to the chassis.**
- **DO NOT EXCEED YOUR GVWR!** This means you should weigh your vehicle as loaded for your normal travel to determine the actual weight. If you exceed the GVWR, you **MUST** remove items from the motorhome, or drain liquids, then re-weigh the vehicle to ensure you have achieved a safe weight.
- The actual weight of the vehicle, passengers, all options, liquids, the hitch weight of your towed vehicle and your personal cargo is important for you to know so you do not exceed the Gross Vehicle Weight Rating (GVWR) of the motorhome. The volume of space available for storage may exceed the amount of available cargo capacity. Large storage compartments have been designed to accommodate normal camping items, which are bulky, but not necessarily heavy.

Store and secure all loose items inside the motorhome before traveling. Overlooked items can become dangerous projectiles during a sudden stop.

Distribute cargo side-to-side so the weight on each tire does not exceed one half of the GAWR for either axle. Make sure any tie down straps (if so equipped) on appliances or furniture are secure. Load heavy objects on the floor, or as low as possible.

⚠ WARNING

- **Your recreation vehicle's load capacity is designated by weight, not by volume, so you cannot necessarily use all available space when loading the vehicle.** Do not exceed your GVWR and ensure you are loading the vehicle as evenly as you can for the best possible handling. Ensure heavy items are secured so they do not shift during travel.
- Store items in areas designated for storage. **Do not store anything in the areas reserved for the converter, electrical panels, furnace or water heater, etc.**
- For traveling safety, it is important to make sure the tie down straps are secured on all appliances such as the toaster, coffee maker, etc. Vibration during travel will move the appliances, creating the potential for them to fall out of their cabinets possibly causing injury.

SECTION 3: PRE-TRAVEL INFORMATION

TRAILER PLUG

If you choose to tow behind your RV, a chassis manufacturer supplied 7-way trailer plug (located at the hitch) is pre-wired into your motorhome. Before hitching up to a trailer, please read *Using the Rear Hitch*, vehicle weight ratings, etc. Your motorhome may have both 4-way and 7-way trailer receptacles.

Wiring to operate your towed vehicle brakes must be the same size in both the towed vehicle and the motorhome.

White	1	Ground
Blue	2	Electric Brakes
Green	3	Running lights
Black	4	House batteries charge line
Red	5	Stop & left turn
Brown	6	Stop & right turn
Yellow	7	Back up Lights



**7-way trailer
plug-rear
view**



**12V
Circuit
Tester**

The connector plug may build up corrosion with extended use. It should be cleaned periodically to insure good electrical contact. Make sure the connector plug is kept clean and protected from road elements as you travel.



NOTE: A 12V circuit tester is recommended to verify trailer connections.

WEIGHING YOUR MOTORHOME

When your motorhome is loaded you should have it weighed. The actual weight of the motorhome, passengers, all options, liquids, the hitch weight of your towed vehicle and your personal cargo is important for you to know so you do not exceed the GVWR. There are two important factors when loading your motorhome, total weight and balance.

It is imperative that you verify compliance within all applicable weight ratings. Overloading your motorhome will void the **Limited Warranty** and the warranties of many component part manufacturers.

Periodically weigh your motorhome at a public scale to determine proper load distribution. To obtain the side-to-side weights, there needs to be enough space on either side of the scale to accommodate the motorhome being partially off the scale.

Different types or scales may require different procedures when weighting the motorhome. The motorhome must remain as level as possible on the scale (even if an axle is not physically on the scale). To obtain the side-to-side weights, make sure there is enough space on either side of the scale to accommodate the motorhome being partially off the scale.

If a boat, trailer or other vehicle is being towed, it should be weighed separately. Combine this weight with the motorhome's Gross Vehicle Weight (GVW) to ensure the total combined weight does not exceed the GCWR.

Once actual weights are obtained, compare them to the **Weight Information Label** weight ratings to ensure you are below the posted minimum ratings.

If there is a difference in the weights on one side of the vehicle as compared to weights on the other side, components (tires, wheels, brakes, springs, etc.) on the heavier side may be overloaded, although the total axle load is within the GAWR.



CAUTION

It is important to redistribute the load to avoid component failure as well as to improve the handling characteristics of the vehicle.



WARNING

Dump the gray and black water holding tanks before traveling to avoid carrying unnecessary weight. Full tanks can affect your fuel consumption, and depending on tank location, can affect your vehicle handling characteristics. If you cannot immediately empty your holding tanks, reduce your vehicle speed until you reach a dumping station.

See the *Weight Terms and Loading Your RV* sections for important information on how towing a vehicle affects the motorhome weight.

SECTION 3: PRE-TRAVEL INFORMATION

Notes:

VEHICLE OPERATION

Your motorhome will travel safely and comfortably at highway speed limits. However, it will take longer than a passenger automobile to reach that speed. Allow more time to go around the vehicle you are passing. Avoid situations that might require sudden momentum changes as the length of the motorhome affects your ability to quickly cut back into traffic. Swerves and sharp turns, especially at high speeds, could result in loss of control of the motorhome.

The motorhome has a longer turning radius. When turning, check the road clearance and be aware of others, especially if towing a vehicle behind your motorhome.

Adverse weather conditions and extremes in terrain may affect the performance and handling of your vehicle. Do not operate the cruise control on icy or extremely wet roads, gravel roads, winding roads, in heavy traffic, or in any other traffic situation where a constant speed cannot be maintained. Use care when accelerating or decelerating on a slippery surface. Abrupt speed changes can cause skidding and loss of control.



NOTE: CALIFORNIA TIRE CHAIN NOTICE:
YOUR MOTORHOME MAY NOT BE OPERATED
WITH TIRE CHAINS

Braking and Stopping

Even though your motorhome is equipped with brakes designed for its Gross Vehicle Weight Rating (GVWR) we suggest you practice stopping away from traffic until you become accustomed to your motorhome's stopping distance. Your motorhome is equipped with a third brake light that activates when the brakes are engaged.

When descending a long hill, shift the transmission into a lower gear and engage the auxiliary engine braking. Auxiliary engine brake engagement is activated by a switch on the driver's console.

See the chassis owner's manual for additional information. The transmission and engine will help in controlling downhill speed and can lengthen brake life. The distance required to stop the motorhome is greater than an automobiles.

Driving through water deep enough to wet the brakes may affect stopping distance or cause the vehicle to pull to one side. Check the motorhome's brake operation in a safe area to be sure they have not been affected. **Never operate any vehicle if a difference in braking efficiency is noticeable.**

 WARNING

Your motorhome chassis braking system is rated for operation at GVWR not GCWR.

Parking Brake

The parking brake should be engaged when the motorhome is parked. Never drive your motorhome with the parking brake engaged as this will reduce braking effectiveness and cause excessive driveline wear. Refer to your Chassis guide for more information on the parking brake.

USING THE REAR HITCH

CAUTION

Do not install a frame equalizing type hitch on your motorhome.

Towing will affect vehicle handling, durability and fuel economy. Exceeding any of the listed weight ratings will result in unacceptable overall vehicle performance. Your safety and satisfaction require proper use of correct equipment.

The factory installed towing hitch on this vehicle is capable of pulling 7,500 pounds of load (maximum), and a maximum vertical (tongue) weight of 750 pounds. A hitch bar of appropriate strength and steel should be selected to meet the capacities of the towing receptor.

Always use safety chains between the motorhome and the towed trailer or vehicle. Cross the chains under the tongue and allow for slack when turning corners. Connect the safety chains to the vehicle frame or hook retainers. Never attach the safety chains to the bumper.

Before descending a steep or long grade when towing a trailer or vehicle, reduce speed and shift the motorhome into a lower gear to control vehicle speed. Avoid frequent or prolonged brake application, which can cause overheating or brake failure.

By definition the GCWR is “the maximum total weight rating allowed for a vehicle and any attachment, such as a trailer or towed vehicle. To determine the total allowable weight for a towed item, subtract the GVWR from the GCWR.

WARNING:

YOUR MOTORHOME CHASSIS BRAKING SYSTEM IS RATED FOR OPERATION AT GVWR, NOT GCWR. CONSULT YOUR OWNER'S MANUAL(S) FOR SPECIFIC WEIGHING INSTRUCTIONS AND TOWING GUIDELINES. THE BRAKING CAPACITY OF YOUR MOTORHOME IS NOT NECESSARILY AS GREAT AS THE TOWING CAPACITY. SEPARATE BRAKING SYSTEMS MAY BE NECESSARY FOR CONTROL OF A TOWED VEHICLE. (AUTO, TRAILER, BOAT, ETC.) BEHIND THE MOTORHOME. IF THE TOWED VEHICLE MEETS OR EXCEEDS THE MINIMUM WEIGHT AS DETERMINED BY THE CHASSIS MANUFACTURER (THIS MINIMUM WEIGHT RATING WILL VARY BY CHASSIS AND CHASSIS MANUFACTURER), CONTACT YOUR CHASSIS DEALER OR MANUFACTURER FOR ASSISTANCE IN DETERMINING WHETHER A SEPARATE BRAKING SYSTEM IS RECOMMENDED AND WHAT LIMITS THERE ARE FOR YOUR TOWING COMBINATION AND TRAVELING SAFETY.

Towing and Braking Label

WARNING

- Total weight of your motorhome and any trailer or vehicle towed by it must not exceed the GCWR.** Do not assume that you can tow a vehicle that happens to be within the capacity of the hitch. By doing so, you may exceed the total GCWR of the motorhome.
- The total weight of your motorhome (including cargo, passengers, fluids, etc...) in addition to the vertical (tongue) weight must not exceed the GVWR and/or any GAWR.** Once again, do not assume that you can tow a trailer or vehicle that happens to be within the vertical (tongue) weight capacity of the hitch. By doing so, you may exceed the GVWR and/or GAWR of the motorhome.
- Your motorhome chassis braking system is rated for operation at GVWR, NOT GCWR.** Any trailer or vehicle being towed by your motorhome must have adequate brakes as required by all state (or province) and local regulations for towing with your motorhome, including areas you may be traveling through. **Failure to follow the towing guidelines may result in property damage or injury.**

In addition, a separate supplemental braking system must be installed if the towed trailer or vehicle meets or exceeds the minimum weight determined by the chassis manufacturer (*this minimum weight rating will vary by chassis and chassis manufacturer*).

Contact your dealer for assistance in determining whether a separate braking system is recommended for your towing and traveling safety. Failure to follow these instructions will create a safety hazard and may result in an accident.

Maintenance

Keep the hitch clean along with your general frame maintenance.

- At the beginning of the season, and monthly or thereafter, clean the inside of the receiver tube with a wire brush and spray with a silicone spray.
- Always remove the utility mount from the receiver when it is not in use. This will help prevent the utility mount from rusting to the tube.
- Periodically check the bolts for tightness. They need to be torqued to the proper setting (refer to your Chassis Guide).

Refer to the *Trailer Plug* section for information on the trailer plug hook-up.

POWER ENTRANCE STEP

The electric door step opens automatically when the screen door is opened. Constant 12-volt power to the electric step is supplied through a circuit breaker.

WARNING

LOOK BEFORE ENTERING OR EXITING YOUR Motorhome!

When opening the door from the outside, make sure you are not obstructing the path of the entrance step. Step deployment takes approximately two seconds. Keep hands and fingers clear while extending or retracting the entry door step.

ENTRANCE DOOR

Always hold onto the entrance door when opening or closing it. Damage caused because you failed to do so is not covered by the **Limited Warranty**.

CAUTION

Make sure the entrance door is completely closed and locked when traveling. Locking the door helps prevent it from opening unintentionally and keeps intruders from your recreation vehicle.

The entrance screen door may be equipped with a slide panel that allows access to the entrance door handle and locks. The entrance door may also be equipped with both a regular door lock and a dead bolt lock.

Keys

Several keys are provided when you purchase your vehicle. Most keys have an individual key number stamped on the plate. Record these key numbers and keep the information in a safe place. You can order a key blank from your dealer to have duplicate keys made. If you lose the keys, contact your dealer or a locksmith for assistance.

SECTION 4: VEHICLE OPERATION



NOTE: Locks on entrance and baggage doors need biannual lubrication using a light coat of silicone spray. Conditions such as rain, salt, dust and pollution may increase the maintenance needs.

DRIVER AND PASSENGER SEAT

WARNING

- Do not adjust the seat while driving. After adjusting the seat, make sure that it is locked in position. To ensure that the seat is locked securely, try to move the seat forward or backward without using the adjusting lever or button. Do not put packages, pets or other objects between the driver's and front passenger co-captain's seat.
- If equipped with reclining seats: to minimize the risk of personal injury in the event of a collision or sudden stop, always keep both the driver's captain and passenger co-captain seat backs in a nearly upright position while the motorhome is moving. The protection provided by the seat belts may be reduced significantly when the seat back is reclined. Reclining the seats while the motorhome is moving may result in serious injury.
- If equipped with power seats: keep hands and feet clear of the power seat while in operating the power feature.



NOTE: The driver's and front passenger seat must be locked in the forward facing position while the motorhome is in motion.

6-way power seat (if so equipped)

Use the controls to slide the 6-way power seat to the desired position. Release the control, and the seat will lock at that position. The 6-way power seat has a three-point adjustable seat belt. Features include lumbar support, swivel, slide and reclining capabilities.

To rotate the driver/passenger seat (if so equipped)

To face the driver or front passenger seat toward the rear of the vehicle, pull the seat swivel release lever up and rotate the seat. To return the seat to the original position, rotate seat back to the driving position until you hear a click and the seat locks into position.

SEAT BELTS

⚠ WARNING

Seat belts should always be worn by anyone who drives or rides in this vehicle.

- Never use one seat belt for more than one occupant. Never carry more people in the motorhome than there are seat belts.
- Only seats equipped with seat belts are to be occupied while the vehicle is in motion. While traveling, do not occupy beds or any seats that do not have seat belts.
- Be sure to lock all doors before driving. Locking the doors and using the provided seat belts will minimize the risk of injury or ejection in an accident.
- If you are pregnant, consult your health care professional for advice on seat belt use.

Always use seat belts: In an accident, injury to the driver and passengers may be reduced if seat belts are properly used. The booth dinette, hide-a-bed sofa, and easy bed sofa have two-point lap-seat belts installed. **Seat belts should be used in all seating positions.**

Maintenance and inspection of seat belts:

The webbing used in seat belts may be cleaned with a mild soap or detergent solution. Allow the belts to dry in the shade and do not allow them to retract until fully dry.

Regularly check the seat belt buckles and release mechanisms for positive action and check automatic locking retractors for positive engagement.

If the seat belt webbing shows obvious cuts, protruding broken fibers or severe fading which indicates weakening by exposure to sunlight, the entire seat belt assembly should be replaced. Do not try to bleach or re-dye the belts. The resulting color may rub off and the webbing strength could be affected.

CHILD SAFETY RESTRAINT SYSTEMS

When transporting infants or small children, an appropriate child safety restraint system should always be used. Follow the manufacturer's instructions for the correct installation and use of these systems.



NOTE: All child safety restraint systems should always face the front or rear of the motorhome. They should never be installed so the occupant is facing the side of the motorhome.

OUTSIDE REARVIEW MIRRORS

CAUTION

Adjust the outside rearview mirrors before driving.

After adjusting the front driver's seat, adjust the outside rearview mirrors to your driving preference. Have someone help you adjust the mirrors in the desired direction for maximum rear visibility before driving. During travel, vibration may loosen the fitting holding the mirror(s), causing them to change position. As part of your regular motorhome maintenance, check and adjust the mirrors to the desired position.

Power Remote Mirrors (if so equipped)

You can adjust the power remote mirrors when the ignition key is in the ON position.

1. Move the control knob to the side you want to adjust.
2. Press the control arrows in the direction you want the mirror to move.
3. Return the control knob to the center to lock the mirror(s) into place.

The power remote mirrors also contain heating elements to defog or de-ice the mirrored glass if needed. To activate this feature, use the "Mirror Heat" control located on the driver's side console next to the mirror control joystick.



**Remote Mirror Control /
Mirror Heat Control
(appearance may vary
by model)**

NOTE: Depending on models, the mirror control joystick and the Mirror Defrost toggle switch may be separated from each other. The Mirror Defrost switch may be renamed Mirror Heat.

REAR VISION CAMERA

The rear vision monitor gives a limited televised view of what is behind your motorhome. The rear vision camera will aid you in backing up the motorhome, and can be used for a greater field of vision when driving in heavy traffic.

Your RV may also be equipped with side view cameras mounted in the mirrors or on the body of the motorhome (facing rearward) to give you views down each side of the motorhome. Check the outside rear view mirrors when driving and backing for a more complete field of vision.

The monitor is operational whenever the engine is running. To use the monitor, flip the switch from standby to ON (the monitor will also work when with the motorhome is in "reverse" and the monitor in standby). **Make sure you turn the monitor to standby while driving to avoid being distracted.**

Never operate the rear vision monitor in the ON position for extended periods of time as this may result in an "image burn" on the monitor.

For detailed operating and safety information, refer to the manufacturers user guide.

⚠ WARNING

- Camera/monitor system aids in the use of, but does not replace vehicle side/rear-view mirrors.**
- Objects in camera/monitor view are closer than they appear.** When backing up, proceed cautiously and be prepared to stop.

CAMPSITE HOOK-UP

- Refer to *Electrical Systems* section before connecting the shore line power cord (when using full hook-up) OR before starting the generator (if so equipped) or operating the vehicle on 12-volt power when dry camping.
- Refer to *Fuel & LP System* section before using the LP system. Open the LP gas tank valve (if so equipped) slowly. There may be air in the lines and five to thirty seconds of time is needed to bleed air before LP vapor fills the lines.
- Refer to *Plumbing Systems* section before connecting the fresh water supply or turning ON the water pump or water heater.
- When using full hook-up, connect the sewer hose to the campsite sewer hook-up.
- If applicable, start the refrigerator and the cooling or heating system.



NOTE: For extended dry camping, management of all your resources is essential. Check your battery levels and conserve battery power, use it sparingly

LIPPERT LEVEL UP® MOTORHOME LEVELING SYSTEM (IF SO EQUIPPED)

Your recreation vehicle may be equipped with a 4 point automatic leveling system. The control panel is typically located inside the entrance door or in an outside basement compartment.

The following is an overview of the system to be used as a quick reference. **For detailed operating and safety instructions refer to the manufacturer's owner's manual.** Depending on your model, the system may vary slightly from the following instructions. Familiarize yourself with the operating and safety instructions prior to using the leveling system.

⚠ WARNING

Failure to act in accordance with the following warnings may result in serious personal injury or death!

- ❑ **Never lift the recreation vehicle completely off the ground.** Lifting the RV so the wheels are not touching the ground will create an unstable and unsafe condition and may result in serious personal injury or death.
- ❑ The leveling system is designed **only** for leveling the unit and should **never** be used to provide service **for any reason** under the recreation vehicle such as changing tires or servicing the system. It is **not** recommended that you change a tire yourself.
- ❑ Clear all jack landing locations of debris and obstructions. Locations should also be free of depressions.
- ❑ When parking the RV on extremely soft surfaces, utilize the load distribution pads under each jack.
- ❑ People and pets should be clear of the coach while operating the leveling system.
- ❑ Keep hands and other body parts clear of fluid leaks. Oil leaks may be under high pressure and can cause serious skin penetrating injuries.
- ❑ The use of the electronic automatic leveling system to support the coach for any reason other than which it is intended is prohibited and will violate terms of the limited warranty.

Prior to operation, make sure the following conditions are met:

- ❑ The recreation vehicle is parked on a reasonably level surface. EXCESS ANGLE will appear on the LCD display if the coach is 3.5° out of level front to rear or side to side. Refer to error modes in the OEM operating manual in your warranty packet.
- ❑ All pets, persons and property are clear of the unit while in operation.
- ❑ Battery should be fully charged or unit plugged into shore power.



Leveling Control Panel Callouts

Up arrow: scrolls up through the menu on LCD

Down arrow: scrolls down through the menu on LCD

Enter: activates modes and procedures indicated on LCD

Retract: places leveling system into retract mode. Manual Mode ONLY.

(Press and hold down for (1) second to initiate auto retract)

LCD display: displays procedures and results

Auto level: places leveling system into auto level mode

Front jack button: activates both front jacks in manual mode

Left jack button: activates left leveling jack(s) in manual mode

Right jack button: activates right leveling jack(s) in manual mode

Rear jack button: activates both rear jacks in manual mode

Power button: turns leveling system on and off

Auto Level Sequence

Zero Point Calibration MUST be set before starting the Auto Level sequence.

1. Begin with a manual leveling sequence to get the vehicle to the desired level point
2. Then activate the Level Zero point configuration mode as follows:
 - Turn the panel OFF.
 - Press the FRONT switch 10 times.
 - Press the REAR switch 10 times.
 - A tone will sound and the display will read ZERO POINT CALIBRATION.
 - Press ENTER to set the zero point.
3. Screen will display Zero Point Stability Check and PLEASE WAIT.
4. Tone will sound and the screen will display ZERO POINT SUCCESSFUL.
5. Control will then turn OFF.

For Diesel Units with Air Bag Suspensions ONLY

The leveling control will automatically detect an air bag system.

If the unit does not use air bags, the display will read “NO” for air bag control.

If the display reads “NO” but an air bag system is present on the unit:

1. Confirm harness is connected properly.
2. Run Auto-Level function.
3. Recalibrate the Zero Point.
4. If the air bag system is still not being detected, contact the OEM for further information.

User Alarm Mode

If the alarm system detects that the park brake has been disengaged while at least one jack is not fully retracted and the sensor value changes in any axis more than a predefined amount, the panel will signal this error to the user.

When in alarm mode, all LEDs will flash and buzzer will beep. The Status LEDs will show the system status.

The system performs an automatic retract. No other features are available in this mode.

Miscellaneous

- The system automatically shuts down after 4 minutes of no operation. To reset the system, the coach ignition **MUST** be turn off, then back on, and the power button on the Control Panel **MUST** be pressed again.
- Auto leveling cycle cannot be started until all jacks are fully retracted. Make sure jacks are retracted before attempting to auto level. (Unit will perform a full retract automatically if jacks are down on the request of an auto cycle.)
- System will refuse any operation when a low voltage condition is present.
- System will automatically alarm and retract if the park brake is disengaged and jacks are not retracted with any change in sensor readings. In alarm mode, the only available feature is to retract all jacks.
- Please note WAIT display shows the status of Air/Auxiliary features.



NOTE: The LEDs blink differently when in special controller modes (error, alarm, and configuration). Learning how to recognize these modes is important. Excess angle LED blinks whenever the Y axis (vehicle length) is over 5 degrees from programmed level point.

SECTION 4: VEHICLE OPERATION

Low Voltage Signal

1. The vehicle requires 12.7V DC to operate in the AUTO mode. If voltage is too low, screen displays LOW VOLTAGE. If voltage drops below 12.7V DC, the system will only operate in MANUAL MODE and continues to display LOW VOLTAGE.
2. Minimum Voltage – If voltage drops below 9.5V DC during AUTO or MANUAL operation LOW VOLTAGE will appear on display and system stops operating.

Automatic Leveling Procedure



NOTE: Pressing any button during an AUTO LEVEL sequence will abort auto leveling.

1. Push power button (right corner). System is operational and electronic level lights become active.
2. Check to see that the Control Pad ENGAGE PARKING BRAKE is engaged.
3. Press the AUTO LEVEL button to begin the automatic leveling cycle.
4. Push the power button to de-energize the system.

Manual Leveling Procedure



NOTE: When leveling your coach, the coach should be leveled from FRONT to REAR first (steps 2-4). When the is level FRONT to REAR, then level the coach LEFT to RIGHT (step 5).

1. Press power button on control panel. System is operational and power light will be lit.
2. Press DOWN ARROW to display MANUAL LEVEL on the display. Press ENTER to set.
3. Press FRONT button until jacks contact the ground and lift front of the coach 1 to 2 inches.
4. Press REAR button until jacks contact the ground and lift the rear of the coach. Keep the button depressed until the level indicator displays level.
5. Press LEFT or RIGHT button. If level indicator is toward left of coach, press RIGHT button. If level indicator is toward right of the coach press LEFT button. Keep the button depressed until level indicator displays level.



NOTE: The right and left jacks are used to level the coach side to side. Pushing LEFT on the control panel will extend both left jacks. Pushing RIGHT will extend both right jacks. Jacks always work in pairs; both front, both right, etc.

6. Repeat steps 2 through 5 if needed.
7. Turn power off to the leveling system by pressing the power button.
8. Visually inspect all jacks to ensure all shoes are touching the ground. Should one of the rear jack shoes not touch the ground, press the corresponding LEFT or RIGHT button to lower the non-compliant jack to the ground.

WARNING

Failure to act in accordance with the following warning may result in serious personal injury or death!

- WHEELS MUST **NEVER** LEAVE THE GROUND DURING LEVELING OF THE RV.

Jack Retract Procedures

1. Press the power button to energize the system. LCD screen will display JACKS DOWN.
2. Press DOWN ARROW to display AUTO RETRACT on the screen.
3. Press ENTER to begin automatically retracting the jacks.



NOTE: If you wish to stop retracting the jacks, turn the system off and back on again by pressing the power button twice. The coach can then be manually leveled by following steps 1-5 in the Manual Leveling Procedure section above. Press ENTER to acknowledge.

4. When the JACKS DOWN display goes off, press the power button on the Control Panel to de-energize the system. After a brief visual inspection around the coach to verify the jacks are all fully retracted, you may proceed to travel.



NOTE: To retract in the MANUAL mode, press the RETRACT button until it lights. By pressing any of the JACK buttons (LEFT, RIGHT, FRONT, REAR) the jacks will retract in pairs. (i.e. FRONT retracts both front jacks, etc.).

5. AUTO RETRACT can also be commenced by pressing and holding the RETRACT button for 1 second.



NOTE: In cold weather operation, always check to make sure all jacks, slide rooms and steps are fully retracted before travel.

SECTION 4: VEHICLE OPERATION

Jacks – Manual Override

In the event the jacks will not extend or retract there is a manual override procedure where the jacks can be manually overridden with the use of a hex wrench. For specific instructions on the override procedure refer to the *Lippert Level UP Motorhome Leveling Owner's Manual* found in your warranty packet.

Drive Away Protection System

If the ignition is in the "RUN" position, jacks are down, and the operator releases the parking brake, all indicator lights will flash and the alarm will activate. The system will then automatically retract the jacks until the jacks are fully retracted or the operator resets the parking brake. The power unit will also operate to keep the jacks retracted in the event the leveling system loses pressure as the coach is being driven.

Jacks Down Alarm

The LCI Level UP Motorhome Leveling System is designed to sound an alarm and illuminate the control panel in the event of 2 possible scenarios:

- A "RETRACT" hose leaks.
- The pressure holding the jacks in the retracted position falls to approximately 1500 PSI to sound the alarm.

If the alarm sounds and the control panel illuminates and flashes while driving the vehicle:

- Immediately find a place to pull vehicle off roadway.
- Set the parking brake.
- Inspect all jacks, hoses and valves for leaks

If no leaks are observed:

- Turn the control panel ON by pressing the power button.
- Press RETRACT ALL JACKS button
- Wait until "JACKS DOWN" light and alarm turn off.
- Inspect jacks. If jacks are retracted and no leaks are observed, vehicle can be driven.
- For prolonged travel to a service center, be sure to stop and check the disposition of the leveling jacks every so often to make sure they are not extending.

Recommended Fluid

The leveling system is pre-filled and primed and ready to operate direct from the manufacturer. Type "A" automatic transmission fluid (ATF) will work. ATF with Dexron III or Mercon 5* or blend of both is recommended by Lippert Components, Inc.

Troubleshooting information, error codes, and manual override of the power jacks can be found in the Lippert Level UP Motorhome Leveling Owner's Manual found in your warranty packet or contact Lippert Customer Service or your dealer for additional help.

EMERGENCY STOPPING

Always carry road flares or reflective warning signs. Pull off the roadway as far as possible for emergency stopping. Turn ON your vehicle hazard warning flashers. If traveling at night, use three red warning indicators such as flares, reflectors or lanterns as required by the Uniform Vehicle Code and Model Traffic Ordinance as follows:

1. Place the first warning indicator on the traffic side of the recreation vehicle, directed at the nearest approaching traffic.
2. Place the second warning indicator 100 feet behind the recreation vehicle in the center of the lane and toward approaching traffic.
3. Place the third warning indicator 100 feet in front of the recreation vehicle in the center of the lane and away from the traffic approaching from behind.



NOTE: Curves and/or hills may affect the safe placement of warning indicators.

WARNING

For personal safety, always stand off the road and out of the way of traffic.

EMERGENCY TOWING

If your motorhome ever needs to be towed, refer to the instructions in your Chassis Guide. Please contact your road service provider (if applicable) or a qualified service facility for assistance.

Make sure the road service technician reads and is familiar with the information contained in your Chassis Guide regarding emergency towing.

WARNING

- Never allow anyone to go under the motorhome while it is being lifted by towing equipment.
- When the unit is being towed, be aware of the strap locations. Misplaced straps could result in damage to the exterior of your unit. Damage resulting from misplaced straps is the responsibility of the towing company, and is not covered by the unit warranty.

FRONT AXLE TIRE ALIGNMENT

The term alignment refers to both the adjustment angles on the steering axle and suspension and tracking of the rear axle. Steering components, suspension, wheel bearings and even proper loading will affect the alignment.

We recommend you have the front suspension and steering alignment checked and adjusted after you have fully loaded the vehicle according to your needs as part of the vehicle maintenance. Thereafter, it is your responsibility to have the alignment inspected periodically to maintain vehicle steering performance and prevent uneven tire wear as part of your normal maintenance.



NOTE: Always have the alignment checked and adjusted by a qualified shop with the proper equipment to handle heavy vehicles.

SECTION 4: VEHICLE OPERATION



NOTE: A road test by the dealer should be included as part of the pre-delivery inspection. The dealer can check for and correct any steering problems before you take delivery.

After this road test has been completed, front-end alignment and/or vibrations will not be covered as part of the new vehicle limited warranty.

Follow the Chassis Guide maintenance instructions for the front and rear axle for wheel and suspension maintenance, including the brakes and wheel bearings. Contact your Chassis manufacturer for assistance.

WHEEL LUG NUTS/WHEEL LINERS

⚠ WARNING

- Check and tighten the wheel lug nuts regularly to make sure they did not loosen during travel.** Refer to your Chassis Guide for torque recommendations.
- Failure to tighten and maintain wheel lug nuts to the proper torque specification, could allow the wheels to come off while driving, resulting in serious injury or property damage in the event of a collision or loss of vehicle control.

Torque is the amount of rotating force applied to a lug nut, and can only be achieved by using a properly calibrated torque wrench and socket. **Do not** use a 4-way socket or any other type of wrench that does not measure the actual pressure applied to the lug nut.



NOTE: The proper method of tightening wheel lug nuts is with a torque wrench, not with an impact wrench or by hand. Because of the importance of having proper torque on the wheel lug nuts, you should always have the wheels mounted and properly torqued by a qualified technician using the proper tools.

After your first trip, check the wheel lug torque periodically for safety according to your Chassis Guide. If you suspect the wheel lug nuts have loosened at any time, have them checked and torqued to the proper limits immediately.

Lugs should be checked after winter storage, after a wheel removal, before starting a trip or following extensive braking. Refer to the *Wheel Lug Torque Chart*.

Check and re-torque after the first 10, 25 and 50 miles (16, 40 and 80 kilometers). Thereafter, check and maintain the torque according to the listed torque values.

Wheel lugs

If you suspect or notice the wheel stud bolts are cracked or broken, they must be replaced, along with adjacent bolts that have probably also been weakened due to the additional stress placed on them.

Aluminum Wheels (if so equipped)

Clean the aluminum wheels with a cleaner that is designed for use on aluminum and apply an appropriate protection agent. Do not use abrasive cleaners. Wheels exposed to sea water or road chemicals should be cleaned as soon as possible. Be sure to use a sponge or chamois leather (brushes may damage the aluminum wheel surface).



NOTE: If your motorhome is equipped with aluminum wheels, only the outer dual wheels are aluminum, the inner duals are steel wheels.







TIRES

Read and understand the following before taking your first trip in your RV.

Routine maintenance on your RV is important. **To insure your tires are operating safely, regular inspection of the tires and checking tire pressures is absolutely mandatory.**

Alignment, balance and bearing wear will affect tire wear. Make sure to look for cracking, bulging, uneven tread wear, etc.

Tire Wear Diagnostic Chart

Wear Pattern		Cause	Action
	Center Wear	Over Inflation	Adjust pressure to particular load per tire catalog.
	Edge Wear	Under Inflation	Adjust pressure to particular load per tire catalog.
	Side Wear	Loss of camber or overloading	Make sure load doesn't exceed axle rating. Align at alignment shop.
	Toe Wear	Incorrect toe-in	Align at alignment shop.
	Cupping	Out-of balance	Check bearing adjustment and balance tires.
	Flat Spots	Wheel lockup & tire skidding	Avoid sudden stops when possible and adjust brakes.

⚠ CAUTION

Tire wear should be checked frequently. Once a wear pattern becomes firmly established in a tire it is difficult to stop, even if the underlying cause is corrected.

SECTION 4: VEHICLE OPERATION

Tire pressure

DANGER

Failure to follow proper inflation guidelines may result in tire failure, which, under certain circumstances can cause loss of vehicle control or accidents that may result in property damage, bodily injury and/or death.

You must follow the manufacturer's inflation guidelines for maximum load capacity; under-inflation is just as dangerous as over-inflation.

Proper inflation should be monitored closely. Failure to do so could result in the overheating of a tire causing a blowout. Inflation pressure should be as recommended by the tire manufacturer or as the federal label for the recreation vehicle indicates.

When you are using your Recreational Vehicle, check inflation pressure weekly. Pressure should be checked when the tires are cold. During travel, tires heat up and pressure increases. **Do not bleed air from hot tires or your tires may then be under-inflated.**



NOTE: Cold tire inflation pressure is defined as a tire that has not been used for three or more hours, or has been driven less than one mile. Tire inflation pressure of a hot tire may show an increase of as much as 6 psi over a cold tire.

WARNING

- It is recommended that the tire pressure be checked at the beginning of each trip to obtain the maximum life of the tire. Follow the instructions listed on the Federal Certification label, to determine the correct tire pressure. Under-inflation may cause tire failures and swaying resulting in loss of control, injury, death or property damage.

TOWABLE PRODUCTS ONLY

- Towable recreation vehicles are equipped with special trailer (ST) tires that have a maximum speed rating of 65 MPH (104 km/h). **You should not exceed this speed rating.** Exceeding the tire speed rating may result in tire failure, which could lead to an accident causing serious injury or death.

CHANGING A TIRE**⚠ WARNING**

- The motorhome is very heavy. Raising the motorhome to replace the spare tire should only be done with extreme caution by a qualified technician. The vehicle could slip, causing personal injury or death. **DO NOT ATTEMPT TO DO THIS YOURSELF.**
- Do not use the hydraulic leveling jack system to support the motorhome while under the vehicle or changing tires. The hydraulic leveling system is designed as a leveling system only. Do not use the hydraulic leveling jack system as a jack or in conjunction with a jack. It is highly recommended that, should a tire change be required, it be performed by a knowledgeable, trained professional. Attempts to change tires while supporting the motorhome with the hydraulic leveling jack system could result in damage to the motorhome and risk causing serious injury or death.
- When replacing a tire, make sure to replace it with a tire of the same size and specifications (refer to your Chassis Guide for assistance.)

If you experience a flat tire on your motorhome while driving, gradually decrease your vehicle speed (if possible), and move the motorhome to a safe place on the side of the road. Contact your road service provider (if applicable) or a qualified service facility for assistance. **Do not attempt to change the tire or jack the motorhome up yourself;** this is why a jack and a spare tire have not been included with the motorhome.

Make sure the road service technician reads and is familiar with the Chassis Guide information regarding changing the tires. Make sure the wheel lug nuts have been tightened to the proper torque as outlined in your Chassis Guide.

AWNINGS (IF SO EQUIPPED)**⚠ WARNING**

Awnings must be closed (and locked if applicable) while the motorhome is in transit.

⚠ CAUTION

The effects of wind and rain on an awning are unpredictable and can cause severe damage to the awning and/or the recreation vehicle. **Retract the awning if:**

- If wind or extended periods of rain are expected
- If you leave the RV unattended for a length of time, to avoid unexpected climate conditions.

Awning Care

Keep your awnings clean and in good condition to prevent costly repairs.

- Periodically check that the fasteners are tight. Tighten if necessary.
- Keep the awning fabric clean. For detailed cleaning information, refer to the manufacturer's owner information.

SECTION 4: VEHICLE OPERATION

Your recreation vehicle may include one or more of the following options:

- Power window awnings
- Slide out awnings
- Power awning over entrance door

Power switches to operate the awnings are typically found in the control panel above the entrance door.

Electric Patio Awning With Remote Control



NOTE: The electric awning requires connection to a 120-volt power source. Make sure you have sufficient power available before operating your awning (refer Electrical Systems, Calculating electrical load).

In Motion Detector (if so equipped)

Some patio awnings are equipped with a motion detector. If the patio awning experiences extreme or excessive movement, it will automatically retract to the travel mode position.

For detailed safety and operating information, refer to the manufacturer's user guide.

POWER AWNINGS (IF SO EQUIPPED)

WARNING

Awnings must be closed (and locked if applicable) while the RV is in transit.

CAUTION

- The effects of wind and rain on an awning are unpredictable and can cause severe damage to the awning and/or the recreation vehicle. If wind or extended periods of rain are expected, retract the awning.
- It is recommended that if leaving the recreation vehicle unattended for a length of time you should retract the awning to avoid unexpected weather conditions.

Each power awning will have its own control switch, which is typically located on the command center switch panel located inside the entrance door. Pressing and holding the switch will extend or retract the awning.

Carefree® Longitude Awnings (if so equipped)

Offer the following features:

- Scissor style arms that do not require vertical ground supports.
- Adjustable arms with (6) position pitch adjustment.
- Worm gear driver motor eliminating the need for travel locks.
- Single switch operation, 12V motorized awning.

Adjusting the Awning Pitch

⚠ WARNING

- Do not set the individual arm pitch at more than three (3) positions different between the left and right arms. Damage to the arms and the canopy can occur if the awning is retracted when the arms are set at more than three (3) positions difference.
- **DO NOT USE A 110VAC POWER SOURCE FOR THE EMERGENCY OVERRIDE PROCEDURE!** Doing so will permanently damage the awning! Do not use the Emergency Override without following the directions.
- **For awnings under 12 feet:** The arms must be set at an equal pitch. Damage to the arms and canopy can occur if the awning is retracted with the arms uneven.

The longitude arms have 6 pitch adjustment settings. The awning can be extended and retracted in any of these positions without resetting the pitch.

NOTE: Use care when adjusting the pitch as the awning may move abruptly.

1. Hold on to the awning arm to keep it steady while adjusting the pitch.
2. Press in the pitch adjustment pins located on the scissor arm. **Applying LIGHT pressure on the arm will decrease the force required to press the pitch adjustment pins.**
3. Slide the scissor arm to the desired set hole – towards the coach for a lower pitch and away from the coach for a higher pitch.

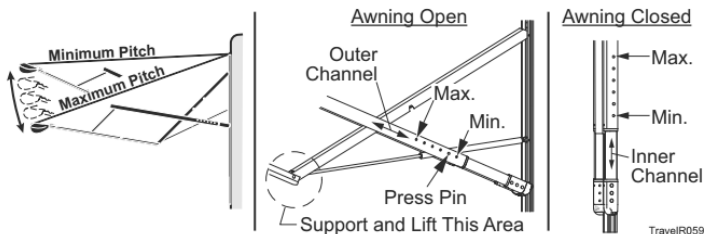

Additional Awning Operation Information

- Operating the awning repeatedly over a short time period may cause the circuit to sense an overheat condition and shut off the motor. If this occurs, wait approximately 15 minutes to allow the motor to cool then operate the awning in normal fashion.
- Normal operation time is 28-35 seconds to extend or retract. If the power supply is on the low side of the acceptable voltage range (10VDC– 14VDC) the awning will move slower.
- Always operate the awning according to the instructions.
- Periodically check that the fasteners are tight (tighten if necessary).
- Keep the awning fabric and arms clean.

SECTION 4: VEHICLE OPERATION

Refer to the manufacturer's user guide for detailed operating and safety information.

Emergency Operation

If power to the vehicle is not available, the awning can be retracted by jumping the motor using a 10VDC – 14VDC power source such as a cordless drill battery or car battery.

1. Remove the front cover (the cover snaps onto the rear cover). Press on both sides of the rear cover until the front cover releases then lift the cover off.
2. Detach the RED and BLACK wires from the cable to the motor.
3. Attach jumper wires to the motor wires.
4. Connect the other ends of the jumper leads to the 10VDC – 14VDC source. If the awning moves in the wrong direction, reverse the leads. Maintain contact throughout the retraction process.
5. When the awning is closed, remove the jumper wires and reattach the cable wires to the motor wires. Be sure to match RED to RED and BLACK to BLACK.
6. Snap the front cover onto the rear cover. Hang the cover on the top and swing it down until it clicks.

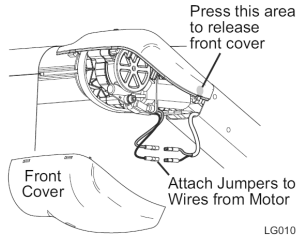

Carefree® Travel'r Awnings (if so equipped)



CAUTION

Power switch should be set to OFF whenever the awning is not being operated and during transport.

- Press the power switch to ON. The Direct Response system is activated and manual controls are active. All functions are disabled if the switch is off.
- Press and hold the EXTEND switch to open the awning.
- Press and release the RETRACT switch. The awning will close completely. To interrupt retraction, press and release the RETRACT switch again.
- When the awning is retracted turn the power switch OFF.



WARNING

DO NOT USE A 110VAC POWER SOURCE FOR THE EMERGENCY OVERRIDE PROCEDURE! Doing so will permanently damage the awning! Do not use the Emergency Override without following the directions.

Emergency Operation

If power to the vehicle is not available, the awning can be retracted by jumping the motor using a 10VDC – 14VDC power source such as a cordless drill battery or car battery.



NOTE: If the awning is equipped with the Direct Response system, this procedure is not applicable. See the manufacturer's owner's manual for additional information.

SECTION 4: VEHICLE OPERATION

Locate and separate the quick disconnects located in the motor arm channel. Position the wires from the motor on the outside of the channel.

1. Attach jumper wires to the motor wires. Connect the other ends of the jumper leads to the 10VDC–14VDC source. If the awning moves in the wrong direction, reverse the leads.
2. Maintain contact throughout the retraction process.
3. Hold the wires from the motor on the outside of the channel while closing the awning. This provides access for opening the awning.
4. When power is restored, use the jumper wires and extend the awning to access the cable disconnects. Re-attach the disconnects and secure in the arm channel.

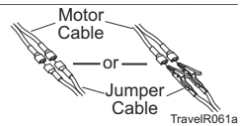
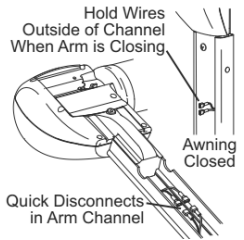

Additional Awning Operation Information

- When rolled out, the fabric may “bounce” creating a wave like motion in the canopy fabric. This can create the appearance of moving jerkily.
- Vinyl may have a tendency to “cling” to the when not used for an extended period of time. Open and close the awning in short bursts 2 or 3 times, the awning will then open normally.

If the awning does not operate, contact the Carefree Service Center. See www.carefreeof-colorado.com for a listing of service centers.

SECTION 4: VEHICLE OPERATION

Notes:

ELECTRIC SLIDE ROOM(S) (IF SO EQUIPPED)

The mechanical components of the slide out are gear driven. Electric powered slideout room systems have a manual override to allow you to extend or retract the slideout room(s) in case of a power loss.

Make sure you have sufficient power available before operating your slideout system.

Level the RV prior to extending the slideout.

Slideout switches are typically located inside the RV, either in the command center or on the wall.

 WARNING

- Make sure the interior slideout room path and the slideout room itself is clear of people and objects before operating.
- Keep away from the slide rails and gear assembly when the room is in motion. They may pinch or catch on loose clothing causing personal injury.

Failure to follow these instructions could result in serious injury or death.

 CAUTION

These guidelines should be followed when using your slideout room:

- Make sure the slideout is in the closed position prior to hooking the unit to the tow vehicle.
- The recreation vehicle **must be level** before operating the slideout room. Water leaks and other problems could result if the slideout is operated without leveling the RV.
- Do not place excessive weight** in the slideout room. It can cause the slideout room to malfunction and cause damage to the slideout.
- Do not over extend/retract the slide out room. Release the switch immediately once the room has been fully extended/retracted. Over extending/retracting the slide out room may result in damage to the stop rod and bracket.
- Additional support jacks are not needed under the slideout. Damage can occur to your slideout room from improper use of aftermarket support jacks.

General Slideout Operation

- The auxiliary battery (customer supplied) must be fully charged and connected. If possible, the RV should be hooked up to 120-volt AC power so the converter operates.**
- The RV must be level and the **stabilizer jacks in the extended position.**
- Slideout switches are typically located inside the RV, either in the command center or on the wall.
- To extend the slideout**, locate the slideout control switch and press the OUT section of the switch; hold until the slideout room stops (travel time is approx. 25 seconds).
- To retract the slideout**, press the in section of the slideout control switch and hold it until the slideout is fully retracted.

SECTION 5: SLIDEOUT SYSTEMS

Operating the switch after the room is fully extended or retracted may damage the switch and motor.

After the slideout is extended, visually inspect the slideout and the surrounding area to make sure the slideout has extended properly and has adequate clearance from any outside obstructions.

If the slideout is equipped with rubber seals, verify that the corners of the black rubber seal are set up correctly. The seal corners are cut at a 45° angle. The top of the outside seal must overlap the side of the seal to avoid the possibility of water penetration. On the inside seal, the side seal should overlap the top.



**Slideout Overlap-
Outside**

NOTE: For long-term storage it is recommend the room be closed (retracted).

General Slideout Troubleshooting Checklist

NOTE: For additional troubleshooting information, refer to the specific slideout system detail.

If the slideout does not move when the slideout switch is depressed, follow these steps:

- Check the auxiliary battery (customer supplied) for a full charge and good wire connections.
- Check the 12-volt fuse or circuit breaker.
- Check for loose connections at the slideout motor.

If the slideout still will not operate, follow these steps:

- If the slideout is extended, refer to the section on operating the specific slideout system installed on your RV.
- If the slideout is retracted, leave it in that position.

If the slideout extends crooked or only one side moves:

- Follow steps on overriding the specific slideout system installed on your RV.
- You may need to push the side that is not sliding to get it to retract all the way.

Contact your dealer or customer service for repair assistance.

Slideout Systems

Your RV may be equipped with one or more of the following slideout systems.

Flush Floor Slideout

For optimum performance, the slideout system requires full battery current and voltage. Although the system is almost maintenance free, actuate the room once or twice a month to keep the seals and internal moving parts lubricated.

NOTE: For long-term storage it is recommend the room be closed (retracted).

Trouble shooting the flush floor slideout

Refer to the general troubleshooting check list before proceeding.

Electric Operation

NOTE: Install transit bars (if so equipped) on the slideout room during storage and transportation.

Extending/retracting the room

1. Level the unit.
2. Main Power switch at stepwell (locations may vary) must be ON.
3. Verify the battery is fully charged and hooked up to the electrical system.
4. Remove the transit bars (if so equipped) if extending the slideout, and install them if retracting the room for travel.
5. Press and hold the IN/OUT switch in the OUT position until the room is fully extended and stops moving. Hold the switch in the IN position to retract the room.
6. Release the switch, which will lock the room into position. If the slideout switch is held after the room is fully extended or retracted, the control will sense that the room has stopped and will shut the motor off after a few seconds.



Manual operation for the flush floor slideout

Locate the crank extension under the inside of the frame (**Fig. 1 and 2**). Attach a standard fifth wheel landing gear crank handle, a 3/4" socket and ratchet, or drill and nut driver.

Rotate the extension clockwise to retract the slideout and counterclockwise to extend it.

DO NOT attempt to disengage the motor as the actuator is "manual ready".

CAUTION

- Always disconnect battery from system prior to manually operating system. Failure to disconnect battery can cause electricity to back feed through the motor and cause serious damage to the system as well as void the warranty
- Use EXTREME CAUTION when extending/retracting the room using the manual override feature.** The gears can be stripped out if the room is manually retracted/extended to its fullest extent and the operator continues to rotate manual override. Damage can also occur to the slide components, slide room structure or trim components. Damages due to misuse of the manual override feature will void any and all claims to the Limited Warranty.

SECTION 5: SLIDEOUT SYSTEMS

MANUAL OPERATION THROUGH FRAME

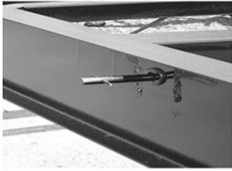

Fig. 1- Crank Handle

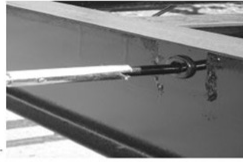

Fig. 2-Through Frame Crank Extension w/Pin

MANUAL OPERATION IN FRAME

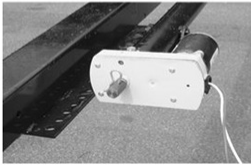

Fig. 3-Hex Head Crank Extension



Fig. 4-Ratchet

Schwintek In-Wall Slideout System

The in-wall slideout system requires no maintenance or adjustments. This system has two vertical columns with a drive motor located at the top of each column. The right and left motors are synchronized by a circuit board. Schwintek slideouts are typically used on both towables and motorhomes.



NOTE: Do not operate the switch after the room is fully extended or retracted as damage can occur to the motor and/or switch.

To operate the slideout using a wireless remote (if so equipped)

- Press the on/off button to power on the remote.
- Press the corresponding button of the slideout you want to operate.
- Press and hold the (extend/retract) arrow button to move the room in or out.
- Press the on/off button once more to power off the remote.

ALWAYS allow the controller to stop both motors before releasing the switch button.

DO NOT try to time the end of the stroke by releasing the button early.

Maintenance

⚠ WARNING

Do not work on your system unless the 12-volt DC (auxiliary battery) and 120-volt AC electrical systems (shore line power cord) have been disconnected.

This slideout system requires very little maintenance. It contains a pre-lubed bearing that is lubricated when the room is moved in and out. Do not spray oil or grease on the rails while the room is extended.

Trouble shooting the in-wall slideout system

Checking Fuses: The in-wall slide requires a minimum 30-amp fuse. Check the load center for blown fuses and replace any if necessary. If the fuse blows immediately upon replacement, there is a problem with the wiring to the in-wall slide control box. **A qualified service person should be called to check and repair.**

Obstructions: Check both inside and outside for possible obstructions. Also check for smaller objects that may be wedged under the floor or in the sides of the unit. Remove any obstructions before proceeding.

Error Codes: Refer to the error codes section for codes and instructions on how to locate the in-wall slide controller.

Low Voltage: The in-wall slide controller can operate with as little as 8 volts; however, with lower voltages the amperage requirement is greater. Check the voltage at the controller and if it is lower than 11 volts, it is recommended that the battery be placed on a charger until it is fully charged. It may be possible to “jump” the RV battery temporarily to extend or retract the room. Consult Customer Service before attempting to “jump” the auxiliary battery.

Only 1 Side Moving: The slide room has a separate motor to operate each side of the room. If only 1 side is moving, with another person’s assistance, press the switch to extend or retract the room while pushing the non-moving side in the appropriate direction. On larger rooms it may be necessary to have 2 or more people pushing the room.

Non-moving side moved manually: Try to push the non-moving side in and out. If a motor shaft has broken it will be possible to move that side of the room several inches by hand. Larger rooms may require several people to push.

Debris in the rack: Check all 4 gear racks on the side of the room for debris.

Status LEDs lights: Locate the slide controller for the slideout in question. Check the status LED lights while pressing the slideout direction switch (in both the extend and retract mode).

Manual override for the in-wall slideout

The slideout system comes with an “electronic” manual override. In event the slide out does not extend or retract follow these steps to override the system which should allow the slideout to be retracted.



NOTE: Fuses for the slideouts can be found in the load center and may be designated as auxiliary or slideout motor.

1. Locate the slideout system controllers. There should be one for each slideout on the recreation vehicle. They are typically located on the forward wall or ceiling of a basement compartment. In some models they may be behind a cargo lined panel.
2. The malfunctioning controller should have a flashing red LED indicating a halt signal fault (will flash 8 or 9 times).
3. Press the “mode button” six times quickly, then press a seventh time and hold for approximately 5 seconds.
4. The red and green LED’s will flash indicating you are in override mode. Release the mode button.
5. Using either a wall or command center panel switch, press and hold the switch toward the word IN or RETRACT until the unit comes in completely. This will allow you to get the recreation vehicle to a service center to have the slideout malfunction diagnosed.

SECTION 5: SLIDEOUT SYSTEMS



CAUTION

Call your dealer or Customer Service if:

- During the override procedure the motors are not synchronized. Visually watch the room, and if one side is moving significantly slower than the other (or not at all).
- If the system stalls out before reaching end of stroke OR if the room does not close and seal tightly.

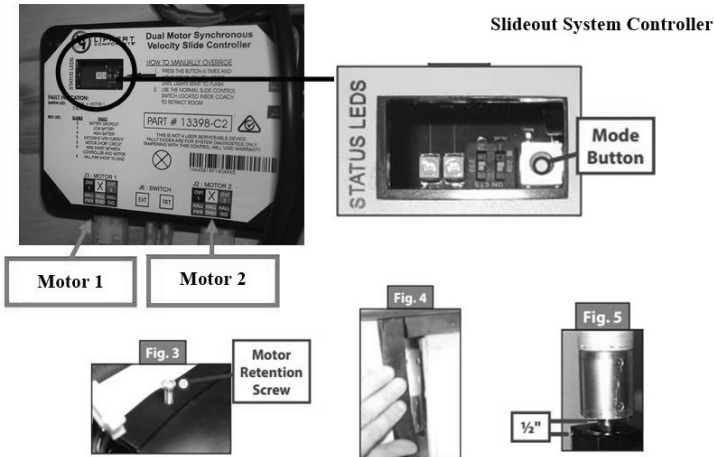

Manually pushing in the slideout

1. Locate the slideout system controller.
2. Unplug motor 1 and motor 2 connectors at the bottom of the slideout controller. This releases the motor brakes for each motor.
3. The slideout room can now be manually pushed in. Larger rooms may require several people to push or pull them.
4. Keep both sides of the slideout relatively even while pushing/pulling.
5. When the room is completely in, *plug both motor connectors back into the control module. This will apply the motor brakes for road travel.*

Disengage motors, manually retract the room and travel lock

1. Locate and remove the motor retention screw, which can be found near the top of each vertical column (Fig. 3).
2. Bend back the wipe seal and visually locate the motor (Fig. 4).
3. Pull the motor up until it disengages (about 1/2 inch).
4. Repeat this process for both sides of the slide room.
5. Physically push/ pull the room back into the opening; keep both sides relatively even.
6. The room must be travel locked to keep the room in place for road travel.

⚠ WARNING

DO NOT MOVE THE RV UNLESS THE MOTORS ARE PLUGGED IN TO THE CONTROLLER AND THERE IS BATTERY POWER TO THE RV. THIS SETS THE BRAKES ON THE SLIDEOUTS TO PREVENT THEM FROM MOVING DURING TRANSIT.

Error Codes

When an error code occurs during operation, the board LEDs lights will indicate where the problem is. For motor specific faults the green LED will blink (1) time for motor #1 and (2) times for motor #2. The red LED will blink 2 to 9 times depending on the error code. Error codes are as follows:

- 2 times **Battery capacity is low** enough to drop below 6 volts while running.
- 3 times **Battery (low) voltage** is below 8 volts at the start of a cycle.
- 4 times **Battery (high) voltage** is greater than 18 volts.
- 5 times **Excessive motor current** (high amperage) also indicated by (1) side of the slide continually stalling.
- 6 times **Motor short circuit:** motor or wiring to motor has shorted out.
- 8 times **Hall signal not present:** encoder not providing a signal; usually a wiring problem.
- 9 times **Hall power short to ground:** power to encoder has been shorted to ground; usually a wiring problem.

The board will need to be reset after an error code. Energizing the extend / retract switch will reset the board; energizing it a second time will return it to normal operation.

Refer to the Schwintek Slide Room Operation Guide for additional troubleshooting information, or contact Lippert at (866) 524-7821 or at www.lci1.com.

Norco Slideout System

The Norco slideout system is a cable driven slide out used typically on towable products.

- The cables guide the room in or out, while the Accu-Slide mechanism evenly powers the corners keeping the room square.
- Motors and cables are behind the interior fascia board around the slideout opening.
- Cables may stretch over time. Average stretch will be approximately 1/8" but it will not affect the function and does not require adjustment.
- Slideout runs off the DC power in the RV.
- Rubber wipes prevent debris from entering the unit and actuation guides the bulb seals to close tightly.
- Self-locking motor freezes the room in any position of travel.
- Slideout is supported by rollers or wear bars not the cables. Cables are used to keep the slideout balanced on the rollers.

If the room will not activate, generally there is no 12V power to the drive motor. The motor is equipped with a hex drive override shaft.

This drive can be activated using an electric drill and the flexible shaft provided with each unit (or use a ratchet to actuate the motor) to pull the room in or out. **If the motor is functioning, check the room for obstructions.**

SECTION 5: SLIDEOUT SYSTEMS

Norco Slideout Manual Operation

1. Locate the included flexible shaft in your owner's packet.
2. Attach flexible shaft to the 1/4" hex fitting on the end of the motor.
3. Attach 1/4" socket & ratchet, or drill to the other end, and turn in the proper direction to move the room.
4. If the cables tighten, and the motor is difficult to turn, **REVERSE THE DIRECTION. OVER-TORQUEING CAN HAPPEN, RESULTING IN SEVERE DAMAGE.**



Power Gear Slideout System

Manual Override - The slideout system is equipped with a manual override that allows you to extend or retract the room in the event of a loss of power.



CAUTION

- Always disconnect battery from system prior to manually operating system. Failure to disconnect battery can cause electricity to back feed through the motor and cause serious damage to the system as well as void the warranty
- Use **EXTREME CAUTION** when extending/retracting the room using the manual override feature. The gears can be stripped out if the room is manually retracted/extended to its fullest extent and the operator continues to rotate manual override. Damage can also occur to the slide components, slide room structure or trim components. Damages due to misuse of the manual override feature will void any and all claims to the Limited Warranty.

If the room does not move when the switch is pressed, check the following:

- Make sure the slideout system is turned on.
- Battery is fully charged and connected.
- Transit bars have been removed (if so equipped).

⚠ WARNING

When the motor brake is disengaged the slideout room WILL NOT lock into place and will not be sealed. When the room has been manually retracted, be sure to install transit bars (if so equipped) and return the motor brake lever to its normal engaged position in order to seal and lock the room into position.

If the room still does not move when the switch is pressed, follow the steps below to manually override the slideout room:

1. Turn the Main Power OFF. The override will not work if it has power going to it. **Do not work on the system unless the battery is disconnected.**
2. Locate the slideout controller. There are two versions of the controller.
3. **Version 1**, unplug the 6 pin wiring harness from the controller.
4. **Version 2**, remove one of the motor leads, either the motor I or motor II lead from the controller.
5. Locate the slideout motor (Fig. 1) mounted to one of the slideout rails. Some models may require removal of the underbelly or cover to access the motor. In a bedroom slideout, it may be located under the bed.
6. Rotate the brake lever, on the backside of the motor, counter-clockwise (looking from the rear of the motor) about 1/8 of a turn to the released position (Fig. 2). This will release the brake that holds the room in place.
7. Locate the manual override for the slideout system (Fig. 1).

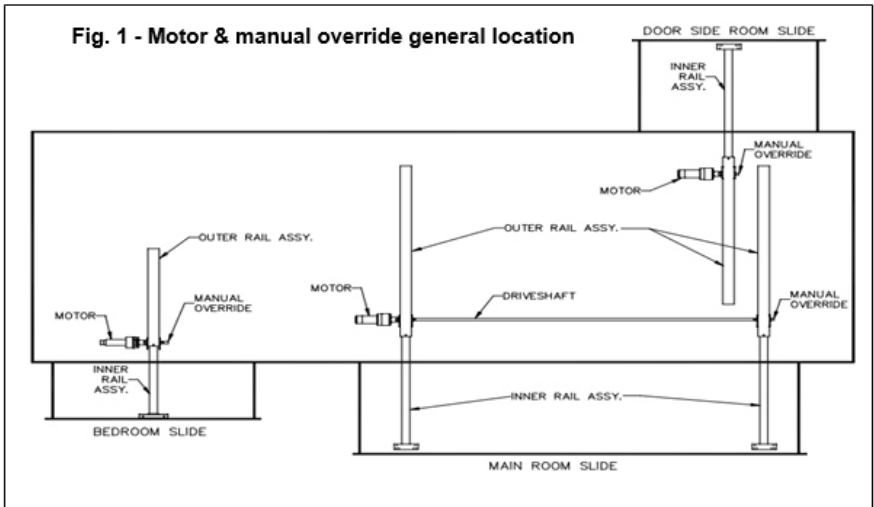

SECTION 5: SLIDEOUT SYSTEMS

1. The room is now free to move. Using either a 5/8" or 3/4" wrench or socket, crank the room either in or out completely. If the slideout system is supplied with a gearbox override (optional), use the crank handle to move the room.
2. When the room is fully in or out have one person apply pressure to the wrench/ratchet and return the brake lever to its engaged position. This ensures the room is locked into a sealed position.
3. Install the transit bars (if so equipped) to the slideout room and take the unit to an authorized dealer for service.

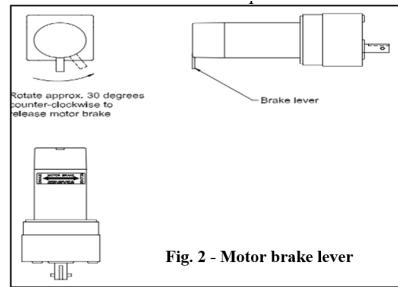

Fig. 2 - Motor brake lever

Refer to the Power Gear® Electric Slideout Operation Manual for detailed operation, safety and troubleshooting information.

Power Gear Slim Rack Slideout System

The Power Gear® Slim Rack slideout is typically used for slideouts 144" long and longer.

- It is operated by a 12VDC electric motor.
- The system is equipped with a manual override allowing the room to be extended / retracted in the event of a power loss.
- The system has a controller (Fig 1) with programmable stops that stop the motor when the room is fully extended or retracted.
- The controller has the ability to detect faults for easier troubleshooting.
- A wall mounted touchpad allows room movement and provides end user feedback.



Fig.1 Slideout Controller

Operating the Slideout

The slideout will not function until the stops are properly set or faults are cleared.

A solid "ON" GREEN LED indicates room movement.

The RED LED indicates a fault or a problem with the system. (Refer to the *Fault Diagnostics / Troubleshooting*).

Prior to moving the slideout room set the parking brake.

To ensure ample voltage is being supplied to the slideout system motor, power should be supplied from one of the following sources:

- Attach the RV to shore power. Have the motorhome engine running.
- Turn on the generator.

Extending/retracting the room

1. Engine or generator must be running, or plugged into shore power.
2. Transmission must be in park or neutral (if applicable).
3. Set the parking brake and level the unit.
4. Remove transit bars (if so equipped) if extending the room; install if retracting.
5. Turn ON the on/off switch or key.

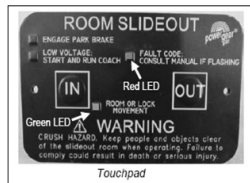

Touchpad

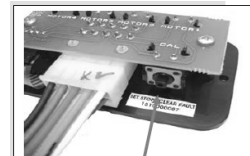

Figure 2 Set Stops/Clear Fault Button

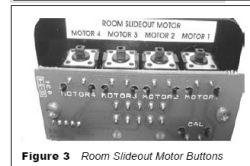

Figure 3 Room Slideout Motor Buttons

6. Press and hold the OUT button (Fig 4). To retract, press and hold the IN button. There will be a slight delay before the room begins moving.
7. The GREEN LED should be solid ON when room is in motion.
8. Release the OUT button when the room is fully extended or the IN button when fully retracted, and stops moving.
9. Turn **OFF** the on/off switch or key.

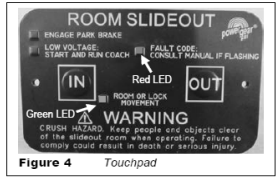

Figure 4 Touchpad

Fault Diagnostics / Troubleshooting

The control has the ability to detect and display several faults. When a fault is detected, room movement stops and two different LEDs will flash in a pattern.

The RED FAULT CODE LED (Fig 4) will flash a number of times corresponding to a specific fault code (refer to the Fault Code Chart).

The GREEN ROOM MOVEMENT LED (Fig 4) will flash GREEN a number of times corresponding to which motor has the associated fault.

Example: (4) RED flashes and (2) GREEN flashes indicate a motor fault on motor 2.

MAJOR and MINOR faults: faults must be cleared for the room to operate normally.

- MINOR** faults can be cleared by pushing and releasing the **IN** or **OUT** buttons on the wall touchpad (Fig 4).
- MAJOR** faults must be cleared by pushing and releasing the **SET STOPS/CLEAR FAULTS** button located on the back of the wall touchpad (Fig 2).

NOTE: For MAJOR faults, the control must be overridden by following the **EMERGENCY RETRACT MODE** in the *Override Modes* section.

Fault Code	Fault Type	Fault Codes		
		Description	Possible Cause	Possible Solution
1	Major	Stops not programmed	-Stops have not been set -Stops were cleared -Stops were improperly set	Stops need to be programmed by an authorized service facility.
2	Minor	System Fault	-Obstruction present -Excessive system drag	Run room in opposite direction. If it continues to move in the opposite direction, remove obstruction, excessive weight in room or repair of damaged component. If room stops moving in opposite direction, observe fault code and refer to this chart

SECTION 5: SLIDEOUT SYSTEMS

4	Major	Excessive Battery Voltage	-Bad or loose connection -Defective harness -Open or shorted motor	-Check all connections at control box and motor -Check the harness for broken wires. -Put 12.0 VDC direct to the motor. If it does not run replace the motor.
6	Minor		Supply voltage to control box is 17.0 V DC or greater	Check 2-pin power connector at control box. If the voltage is 17.0 VDC or higher, contact O.E.M for power and ground supplies
Park brake LED flashing			-Parking brake not set (if applicable) -Ground signal lost at park brake control	-Set parking brake (if applicable) -Check for continuity to ground on wire plugged into park brake connector at control box
Low voltage LED flashing			Incoming voltage to control box is below 12.0 VDC	Check 2-pin power connector at control box. If voltage is below 12.0 VDC contact O.E.M for power and ground supplies.

Preventative Maintenance

The Power Gear® slideout system requires very little maintenance. Read and follow these procedures:

- When the room is extended, visually inspect the slide rail assemblies. Check for excess buildup of dirt or foreign material; remove any debris that may be present.
- If the system squeaks or makes any noises, blow out any debris from the gear rack arms and apply a dry lubricant to prevent and/or stop squeaking.

Refer to the Power Gear® website www.powergearus.com for additional information.

Override Modes

In the event of component failure or loss of system power, your slideout can be manually overridden and retracted for travel.



NOTE: During the override procedure, the unit will exit this mode if the room has not been moved for two (2) minutes or if a fault is detected during room movement. The Fault Code (RED) and Room or Lock Movement (GREEN) LEDs will flash rapidly for 10 seconds to indicate the override procedure failed. After 10 seconds of flashing, the control will automatically default to FAULT CODE 1. Programming must be restarted.



NOTE: After overriding the system, the room control will need to be re-programmed by an OEM authorized dealer.

Emergency Retract Mode

Use this procedure when there is **NO** loss of power or electrical problem with the system.

1. Remove the touchpad (Fig 4) from the wall.
2. Prior to clearing the MAJOR fault, record the number of RED & GREEN flashes observed on the touchpad (Fig 6). This information will help your dealer/service center in troubleshooting the slideout system.
3. Press and hold the SET STOPS/CLEAR FAULTS button on the back of the touchpad for five (5) seconds (Fig 2). Both RED & GREEN LEDs will be on solid while pressing this button. After 5 seconds, the GREEN LED will begin flashing and the RED LED will remain solid on.
4. The unit is now ready to retract the room. Press and hold the ROOM SLIDEOUT MOTOR buttons 1 and 2 on the back of the touchpad (Fig 3).

# of RED flashes	# of GREEN flashes

Figure 6

CAUTION

It is very important to note that during this procedure, the slideout control has NO stop locations. Use a second person to assist in determining when the room is retracted. Damage to the room can occur if the room is retracted too far.

Press the IN button on the front of the wall touchpad until the room is fully retracted. If one side of the room needs to retract further in order to get a good seal, press and hold the motor button (Fig 3) corresponding to **ONLY** the motor you want to move. Press the IN button on the front of the touchpad to retract the room the remainder of the way.

5. Re-install the wall touchpad.
6. Take the unit to an OEM certified dealer for repairs.

Manually Retract Room with Ratchet and Socket

If the power is lost to the slideout motor(s) or the override mode above will not work, the room may be manually retracted using a ratchet and socket attached to the end of the coupler (Fig 11).

1. Gain access to the VERTICAL CHANNEL assembly from inside or outside of the coach (whichever is more convenient). Remove the trim and flange pieces on the slide-out room box.
2. If applicable, remove the top screw from the bulb seal at the top of the VERTICAL CHANNEL (Fig 8).
3. Pull down the bulb seal and remove the motor cover (Fig 9). The motor seal may stick to the bulb seal.
4. Using a pick tool, remove the end of the retaining spring from the motor spring clip (Fig 10A). If not equipped with a retaining spring, loosen the motor retaining screw (Fig 10B).
5. Unplug the motor from the harness and remove the motor by lifting it up and out.

SECTION 5: SLIDEOUT SYSTEMS

- Repeat steps 1-4 for the other side.
- Place a socket wrench with a 3-inch extension and a 5/8" deep well socket (Fig 12) through the motor access opening and seat the socket onto the coupler (Fig 13). One person alternating from side to side of the room can retract a 1500 lb. room with or without a ramp.

NOTE: One person on each side of the room with a ratchet and socket will expedite the process. Room moves ¼ inch for every 30 to 40 degree turn of the wrench.

- Secure the room in place by either:
 - Re-installing the motors (making sure the end of the retaining screw is re-hooked to the motor spring clip (Fig 10A).
 - Torque the motor retaining screw to 40 inch/lbs. (Fig 10B) and the motor retainer is fully engaged.
 - Use a travel lock, (a 2x4 cut to size), etc.
 - Refer to Fig 10A and 10B for proper seating of the motor.**
- Have the slideout room serviced by an OEM authorized dealer as soon as possible. Do not operate the room until service is complete as damage to the room may result.

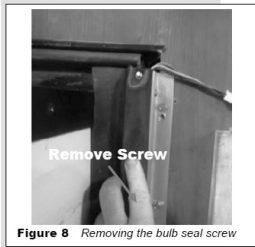

Figure 8 Removing the bulb seal screw

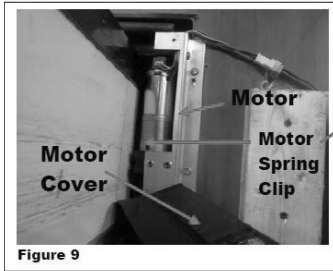

Figure 9



Figure 10A



Figure 10B

NOTE: Motor shown properly seated. No gap between mounting bracket and block.

Motor Retaining Screw

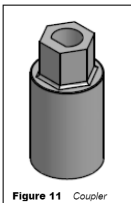

Figure 11 Coupler

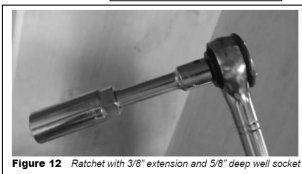

Figure 12 Ratchet with 3/8" extension and 5/8" deep well socket

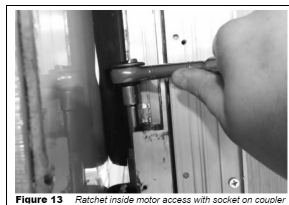

Figure 13 Ratchet inside motor access with socket on coupler

Power Gear Ram Slideout System

Typically used for Class C motorhomes.

Manual Override Procedure

The system has been equipped with 3/4" hex override couplers located on the drive component of the system. Due to the size and weight of some rooms, assistance may be needed to push the room in.

Use the following steps to mechanically operate the room:

1. Locate the ABS motor access cover for the slideout. This cover will be located inside one of the storage compartments under the slide room up at the top of the compartment.
2. Remove 4 screws holding the panel to the top of the compartment. Remove the cover.
3. Unplug the motor leads at the connector. Gray connector with red and black wires.
4. To release the motor brake you must depress the spring lock lever, which then allows you to pivot the brake lever, which in turn releases the brake. These parts are located inside the rubber boot wire tied over the motor. You must manipulate these parts **without** removing the rubber boot. **As noted on the side-by-side photo, removing this boot will void your motor warranty.** These photos will help you figure out how this works. The side-by-side photo (below) shows the spring lock lever and the brake lever.
5. The spring lock lever is a thin metal arm with a slight bend at the end, which will hold the brake lever in the released position.
6. The brake lever is the heavier thicker metal arm with the hole in the end.
7. The normal position for these two levers is to be parallel to each other as shown in the first side-by-side photo. The motor brake is engaged with levers side by side.
8. The brake lever is moveable; the spring lock lever is not moveable. To release the brake lever, you must push the bent end of the spring lock lever away from the brake lever; this will allow you to pivot the brake lever so it moves over on top of the spring lock lever. The bent end will hold the brake lever in the released position. (photo shows this "bend").
9. Once the brake motor is released, you will need to remove the skirting on the side of the slideout floor where the hex override is located.
10. Use a ratchet with a 3/4" socket (or wrench) to turn the hex override and manually move the slideout.
11. When the slideout is retracted, check to make sure you have a good seal, and replace the skirting on the slideout.

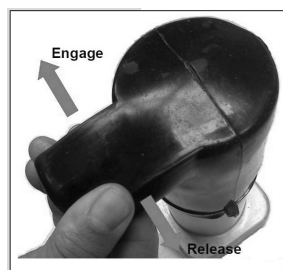
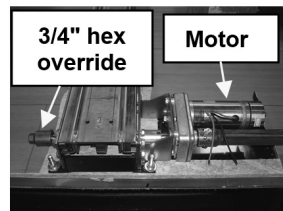
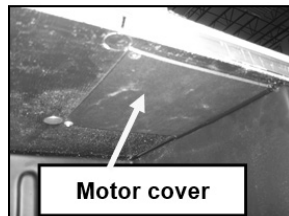

SECTION 5: SLIDEOUT SYSTEMS

12. Return the brake release lever back to the “engaged” position (parallel to the spring lock lever). Pressing the bent end of the spring lock lever will allow the brake lever to be moved.
13. Plug the motor connector back in again.
14. Replace the plastic motor cover with the 4 screws removed previously.
15. Take the unit to an authorized dealer for service.

For further information, refer to the manufacturer’s owner’s manual.

DO NOT remove boot. Removal of rubber boot will void manufacturer’s warranty. Rubber boot removed from end of motor only to show brake lever and spring lock.

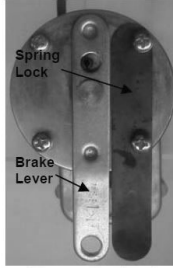

Brake lever engaged

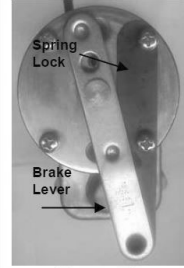

Brake lever released

THE ELECTRICAL SYSTEM

The RV electrical system is comprised of two independent electrical systems. One operates off of 12-volt DC power and the other off of 120-volt 60hz AC power. All installations have been made in compliance with industry standards applicable on the date of manufacture. Because the electrical equipment and associated circuitry are engineered into a dedicated system specific to your RV, do not make unauthorized changes or add fixed appliances to it. **Changes or additions made after delivery may result in a hazardous condition.**

Service and/or modification of the electrical system should only be performed by qualified electrical technicians using approved materials, components, and methods meeting current safety and code requirements. Consult your dealer's service department for assistance.

To read more about the various components incorporated into the RV electrical system, please refer to the information contained in your Warranty Packet.

For motorized vehicles, consult the Chassis Guide for information pertaining to the chassis drivetrain electrical system.

Electrical System Maintenance

Before working on the electrical system:

- Make sure the inverter/charger (if so equipped) is turned "off" before disconnecting batteries. Disconnect the shore power cord.
- If equipped with a generator, turn off the generator and disable the automatic generator start functionality (if so equipped).
- Turn off the battery disconnect switch (if so equipped)
- Turn off the 120V main circuit breaker.
- Disconnect the negative 12VDC battery terminal from the battery.

WARNING

Use caution when using metal tools. If a tool contacts a battery terminal or metal connected to it, a short circuit could occur which could cause personal injury, explosion or fire.

IN CASE OF AN ELECTRICAL FIRE

WARNING

Do not attempt to use water to put out an electrical fire. Water can spread some types of fire, and electrocution is possible with an electrical fire.

EVERYONE SHOULD EVACUATE THE RV IMMEDIATELY:

- Switch the 120-volt main circuit breaker to the "off" position. It is important that everyone knows where to find the main circuit breaker and how it operates.
- Disconnect the negative battery cable(s) at the battery.
- Disconnect the power cord from the shore power receptacle.
- Turn "off" the generator (if so equipped).

Always have faulty or damaged wiring and electrical components repaired immediately.

SECTION 6: ELECTRICAL SYSTEM

CONTROLS AND SWITCHES

Your motorhome is equipped with various switches and controls that allow you to operate and monitor the systems in your motorhome.

Information on these controls and their location will be provided throughout this manual. Additional information on the various components can be found in the component manufacturer's user guide.

COMMAND CENTER

The command center is typically located inside the entrance door or in the living area of the RV, and contains switches and controls for various electrical functions. Command center applications, configurations and components will vary by model.

Command Center Panel or Command Center Panel with Switch Modules

Items found on these panels may include:

- Fuel gauge and hour meter with switches for fuel pump and fuel levels; fuel station (if so equipped) on/off switch
- Lighted red pump and water heater switches (electric & LP gas)
- Generator start / stop switch; may include hour meter
- Tank heater switches
- Light switches for porch lights, exterior security lights, interior lights, awning LED lights, front cap LED accent lights, power entry step
- Cargo bed red lighted control switch
- Slideout control switches (press and hold to extend / retract)
- Awning control switches (press and hold to extend / retract)
- Systems monitor with LED indicators for tank levels and battery charge status
- Auto leveling control panel (for leveling the RV)
- Inverter panel (power switch with display)
- Power bunk bed lift control switch
- Speaker selector switch

Command Center Modules Mounted to the Wall

Some models may have the modules mounted directly to the interior wall of the vehicle. They are typically located near the entrance door.

Touch Dimmer Switch

Certain models may include a touch dimmer switch next to the Command Center panel. (There are no interior light switches on the Command Center panel).

- Turn ON ceiling lights: Tap the LED light on the dimmer
- Turn OFF ceiling lights: Tap the LED light on the dimmer
- Dimmer: If lights are off, hold finger on the LED light and lights will begin turning on gradually until fully lit. If lights are on, hold finger on the LED light and lights begin to gradually turn off.

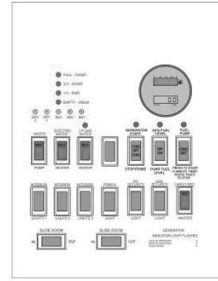

Command Center Panel



Command Center Panel w/Switch Modules



The dimmer has a memory so it remembers what the light setting was when the lights were turned OFF. When turned ON again, the lights return to that same setting.



NOTE: If your RV model includes the 5 way/8 way remote control: the LIGHT button on the remote **only** controls the awning LED lights

GFCI RECEPTACLE

There is a ground fault current interrupter (GFCI) engineered into the electrical system. It is designed to reduce the possible injury caused by electric shock. The GFCI will not protect against short circuits or circuit overloads.

Test all GFCI receptacles monthly:

Push in the GFCI “TEST” button. The GFCI “RESET” button should pop out indicating the GFCI receptacle has been “tripped” and interrupted 120-volt power.

Push in the GFCI “RESET” button to restore 120-volt power.

Contact your independent dealer for assistance if the GFCI “RESET” button does not restore 120-volt power and pops back out.

A “tripped” GFCI breaker indicates that abnormally high 120-volt current flow (a ground fault) was detected. All ground faults must be repaired before use of the recreation vehicle. If the GFCI “RESET” button does not restore 120-volt power and pops back out. Contact your dealer for assistance.

TESTING THE CAMPSITE POWER CONNECTION

The campsite 120-volt power receptacle(s) should always be tested for proper functionality prior to plugging the recreation vehicle shore power cord into it.

Campsite 120-volt power receptacles can be tested using a digital multimeter or a dedicated circuit analyzer. Dedicated circuit analyzers plug directly into the campsite power receptacle and minimally test for open neutral, open ground, and correct polarity. **Polarity indicators can be purchased in most electrical and hardware stores.**

WARNING

Do not hook up the power cord to any receptacle until you have verified proper polarity and grounding.

DO NOT plug the shore power cord into a campsite receptacle(s):

- That has reverse polarity
- With non-functioning ground circuits
- That shows outward signs of heat damage.
- Doing so may result in property damage or serious injury. Plugging the shoreline power cord into an incorrectly wired power source could damage the recreation vehicle electrical system and result in severe or fatal injury. Damage or injury resulting from connection to malfunctioning or improperly wired power sources is not covered by your recreation vehicle warranty.

DO NOT

- Do not use any cheater plug, adapter or extension cord to reconfigure incoming AC power or break the continuity of the circuit connected to the grounding pin.
- Do not connect the power cord into an outlet that is not grounded, or adapt the power cord plug to connect it to a receptacle for which it is not designed.
- Do not remove the grounding pin to connect to a non-grounded receptacle. Removal of the ground pin disables an important safety feature designed to prevent shock and electrocution hazards.
- Do not connect the power cord to an extension cord. Use of an improper extension cord will cause overheating of the cord as well as potentially causing premature failure of the AC equipment.
- The power cord must be fully extended when in use and not left coiled in the electrical compartment or on the ground. If the power cord is left coiled, it may potentially create enough heat to melt its protective casing.

It is the responsibility of the owner of the electrical receptacle to ensure that the receptacle is properly wired and grounded. **Reverse polarity and/or improper grounding of your RV can cause property damage or serious personal injury.**

Connecting The Power Cord

Always test the external power source (i.e., the campsite power receptacle or electrical box) with a ground monitor before connecting your power cord to it. If the ground monitor indicates 'reverse polarity' or an 'open ground' **DO NOT** connect the power cord.

To help prevent power surges from damaging the connected loads, please follow these instructions when hooking up to the external power source:

1. Turn "off" the load center main 120-volt circuit breaker.
2. Carefully extend the entire length of the power cord (approximately 25'-35') from the electric cable hatch to the external power source.
3. Plug the power cord into the receptacle. Be sure all the power cord prongs are properly plugged into the receptacle.
4. Return to your RV and turn "on" the load center main circuit breaker.

The shore line power cord should be unplugged when the recreation vehicle is left unattended. If something would happen to the electrical system, this may help limit potential damage.

When you are ready to leave, reverse the power cord connection process. Use care to prevent damaging the power cord electrical connection pins when connecting or disconnecting the shore line power cord. Grasp the plug to remove the power cord from the outlet; do not unplug it by pulling on the cord.

Maintenance

Inspect the power cord for cuts, cracks and worn insulation. Have the power cord replaced immediately if these symptoms are noticed.

POWER CONVERTER

The power converter converts 120-volt AC power to useable 12-volt DC power when the shore power cord is connected to an external power source.

The converter has a built-in protective thermal breaker that will shut it down should overheating occur. Overheating can be caused by operating the converter above its maximum power output for an extended period of time, or by an obstruction to its ventilation air flow. To reduce converter heat build keep unnecessary 12-volt lights and motors turned “off”. Keep the converters cooling fins and fan clear of obstructions.

- ❑ **USE ONLY A DEEP CYCLE BATTERY FOR RV USE.** Car batteries (CCA rating) are not designed for RV applications. If doing a lot of dry camping use a deep cycle battery rated in amp hours only (NO CCA rating).
- ❑ If using multiple batteries they must be the same brand and type. Adding more batteries will provide longer use of DC appliances when not on shore power but may reduce charging efficiency.
- ❑ The battery works in conjunction with the converter to supply DC power to the RV. A battery is typically only necessary if you do a lot of dry camping or have slideouts and/or a leveling system.
- ❑ Reverse polarity fuse provides protection for the converter when a battery is used. If the battery is connected backwards to the fuse board this fuse would blow preventing damage to the converter.
- ❑ If your lights are dimming or flickering that usually indicates an overloaded converter. Remove some of the load by turning off DC lights or appliances.
- ❑ Fan is controlled by load. It will begin running at 3 to 6 amp DC draw. It increases in speed with a higher load until 14 to 15 amps. Fan is at maximum speed and stays there even with more load. If load drops below 6 amps DC, the fan shuts off.

CAUTION

It is important that the fluid level of any connected batteries be checked on a regular basis. All batteries will “gas” and lose some fluid when continuously connected to any charging source (does not apply to “gel-cell” batteries).

Before checking for converter output voltage, the battery cables must be disconnected at the battery. Make sure the converter is plugged into an AC source (105-132 AC volts). Check the converter output voltage at the battery with a voltmeter. Place the voltmeter probes on the disconnected battery cables. If the voltage reads 13.6VDC with no load, the converter is functioning properly.

If the converter output voltage at the battery reads in the 0.0VDC range, or the battery is not charging, check for:

SECTION 6: ELECTRICAL SYSTEM

- An open inline fuse in the battery wire
- An open wire between the converter and the RV battery
- Loose ground connection
- Improper torques

If the converter fuses and AC voltage are good, but the converter output still reads zero volts, the converter is not functioning properly.

Modes of Operation:

Absorption (Normal) Mode: 13.6VDC range. Batteries are being charged, just at a slower rate. Converter will not work without AC input.

Float Trickle Mode: To get your converter into this mode reduce the load on the system to almost nothing but the battery. Let the system sit for approximately 44 hours.

Converter voltage will drop to 13.2VDC. If the converter sees any load during this period or after it is in Float Mode it will revert back to Absorption (Normal) Mode. 13.6VDC.

Bulk Mode: Converter will not jump into the “Bulk Mode” unless the battery is below 50% of charge, or approximately below 13.2VDC output voltage. There is no way to force it to go into Bulk Mode.

Red LED indicates blown fuse.

Inspection and maintenance

If the 12-volt power converter is not working (auxiliary battery not being charged) check the reverse polarity fuse(s) located on the end of the converter.

There are no customer serviceable parts inside the converter case and the manufacturer’s warranty will be void if the case has been removed. If you have further concerns contact your dealer.

For detailed information on operation and safety, refer to the manufacturer’s owner’s manual.

Converter with Charge Wizard (if so equipped)

Some converters may be equipped with a charge wizard. There are (3) possible charging modes; NORMAL, BOOST and STORAGE. The charge wizard will automatically select the best mode to charge your battery. A green LED next to the wizard mode button will indicate by flashes, which mode is currently being used.

NORMAL MODE: Green LED flashes once per second; battery is between 50% and 90% charged. Green LED will flash 2-3 times per second; battery is 90% charged. Output voltage is 13.6VDC and the converter is safely completing the charge of the battery.

BOOST MODE: Green LED is on solid. Output voltage is 14.4VDC to rapidly charge the battery up to 90% of full charge.

STORAGE MODE: Green LED flashes every 6-8 seconds. Output voltage has been reduced to 13.2VDC; the RV battery is fully charged and converter is maintaining the charge.

MANUAL MODE (Not recommended): The wizard mode button is used to override the charge wizard. Refer to the converter owner’s manual for additional information.

REVERSE BATTERY PROTECTION: Reverse polarity fuse(s) provide protection for the converter when a battery is used. If the battery is connected backwards to the fuse board

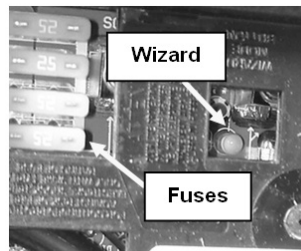

Wizard Button & Reverse Protection Fuses

a fuse will blow preventing damage to the converter. Four easily accessible fuses are located next to the wizard button. Replace with fuses of the same type and rating.

12-VOLT DC SYSTEM

The majority of your motorhome lighting is powered by 12-volt electricity. The 12-volt DC system is composed of components that will operate when the following conditions are met:

- Power is supplied by the chassis alternator when the chassis engine is running.
- The power converter will supply interior 12-volt DC power when the shore power cord is plugged into a 120-volt external power source. The converter will also charge the house batteries in most situations.
- The house batteries power many interior 12-volt components including the lighting fixtures, water pump, 12-volt motors, 12-volt appliances, etc, when the motorhome is not connected to a 120-volt power source.

WARNING

Replacement fuses must be of the same voltage, amperage rating and type. **Never use a higher rated replacement fuse;** doing so may cause a fire by overheating the RV wiring.

12-Volt Fuse Panel

The 12-volt fuse panel is labeled to indicate fuse sizes, positions and the components powered. **Fuses are located in the load center.**

Replacing a Fuse

Before replacing a fuse, always turn off the electrical components protected by it.

1. Disconnect the shore power cord.
2. Turn “off” the inverter (if so equipped).
3. Disconnect the house or auxiliary batteries main negative battery cable.
4. Remove the fuse panel cover to check fuses.
5. Pull the fuse straight out of the fuse block.
6. Insert a new fuse of the same specified voltage, amperage rating and type in the original location.

The fuse panel label should be kept permanently affixed to your recreation vehicle. Fuses will not offer complete protection of the electrical system in the event of a power surge or spike.

12-Volt DC Outlet

There may be one or more 12-volt DC power outlets in your recreation vehicle. When the 12-volt DC outlet is used as a power source for an electric appliance, make sure the appliance operates on 12-volt DC power and that it consumes less than 60 watts (5 amps) of power.

WARNING

Keep the protective dust cap on the 12-volt DC outlet when not in use to prevent ingestion of foreign material and potential short circuit conditions.

BATTERIES

⚠ WARNING

- ❑ **Do not store anything inside the battery compartment(s)** or near the batteries that could touch the battery or battery cable terminals. Contact with the battery or battery cable terminals could cause an electrical short circuit, discharge the batteries, or start an electrical fire.
- ❑ **Keep sparks, cigarettes and flames away from the batteries as the hydrogen gas they create may explode.** Do not connect a booster battery or other power source that outputs more than 14.2-volts DC to the motorhome batteries. Use adequate ventilation when charging or using batteries in an enclosed space.
- ❑ Remove metal jewelry and always wear eye protection when working around batteries.
- ❑ **Do not allow battery electrolyte (acid) to come into contact with skin, eyes, fabric or painted surfaces.** Electrolyte is a sulfuric acid solution that could cause serious personal injury or property damage. If your hands, eyes, clothes or the painted surface of your motorhome are exposed to electrolyte, flush the exposed area thoroughly with water. If electrolyte gets in your eyes, immediately flush them thoroughly with water and get prompt medical attention.
- ❑ **Make sure the inverter/charger is turned “off” before disconnecting the negative battery cable from the battery bank.** Keep the batteries out of the reach of children.

House Batteries

Your motorhome is equipped with Group 27 deep cycle batteries.

Unless a battery has been fully discharged, house auxiliary batteries are normally charged in one of two ways:

- ❑ The chassis alternator charging system supplies power to the house auxiliary batteries when the engine is running and the chassis batteries are sufficiently charged.
- ❑ When the power cord is plugged into 120-volt shore power, or when the generator (if equipped) is operational, the inverter/charger functions as a battery charger and will automatically charge the house batteries when required.

A fully charged battery will read 12.65 volts DC with a specific gravity of 1.265 at 80°F (32°C). A battery is considered discharged at 11.89 DC volts or when it has a specific gravity of 1.120 or less. When voltage drops to 11.89 volts, irreversible battery damage can occur.

Dry Camping

House auxiliary and chassis batteries should be fully charged prior to dry camping. When disconnected from 120-volt shore or generator power (i.e., while dry camping or tailgating) all electrically operated appliances and accessories must be used sparingly. Typically, a deep cycle battery has an amp-hour rating of 75-100 amps.

During this period these appliances and accessories are being powered by the house auxiliary batteries directly, and/or indirectly through the inverter/charger. If excessive amounts of power are drawn from the house auxiliary batteries, they will become deeply discharged. Permanent battery damage will occur after repeated deep discharge cycles.

Battery Inspection and Care

Check the level of electrolyte in each battery cell once a year.

Add distilled water as needed to reach the split-level marker on each battery. Keep batteries and battery terminals clean and tight.

Check the external condition of the batteries periodically. Look for cracks in the cover and case. Make sure battery vent caps are tight and replace them if they are cracked or broken.

Battery storage instructions

To prevent house auxiliary battery discharge when your motorhome will not be connected to shore power for extended periods of time, it is recommended you turn “off” the 12-volt battery disconnect switch, or “main power switch,” **and** disconnect each battery bank at the negative battery cable running to the chassis frame.

During storage, it is important to check battery voltage at least every two weeks and to recharge them as needed. If you remove the batteries from your motorhome protect them from accidental shorting and keep them in a cool, dry, well ventilated area.

Battery Replacement

If house auxiliary batteries need to be replaced, only deep cycle batteries of the same size and type should be installed.

Do not reverse the positive and negative battery cables. Doing so will blow the reverse polarity fuses that protect the power converter.

For more information

Contact the battery manufacturer for more information on the house auxiliary batteries. Refer to your Chassis Guide for information pertaining to the chassis batteries.

12-Volt Battery Disconnect

The 12-volt battery disconnect switch is typically located near the entrance door. This momentary switch controls a solenoid which connects or disconnects the house batteries. The switch lights up red when turned on.

When engaged the battery disconnect solenoid supplies battery power to all accessories connected to the house 12-volt fuse panel. The solenoid must be engaged for the 12-volt house electrical system to operate.

The battery disconnect feature should be used to disconnect the motorhome from house battery power during periods of storage or during maintenance.

If the Main Power switch is turned OFF, the power entrance door steps will still function when the door is opened.

Depending on your model, your motorhome will be equipped with either a Battery Isolator Solenoid or a Battery Isolation Manager.

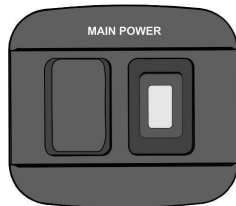

NOTE: The combination carbon monoxide/propane alarm must be connected to a constant 12-volt power source. The carbon monoxide/propane alarm remains operational when the battery disconnect solenoid switch, or “main power switch,” is in the “OFF” position.

SECTION 6: ELECTRICAL SYSTEM

Battery Isolator Solenoid (if so equipped)

The isolator solenoid breaks the connection between the house batteries and the chassis battery when the ignition key is in the “OFF” position.

Breaking this connection prevents discharge of the chassis battery (used to start the engine) when using 12-volt devices in the house section of your motorhome.

When the engine is running the isolator solenoid engages allowing the house batteries to be charged by the vehicle alternator.

Battery Isolation Manager (if so equipped)

Your motorhome may be equipped with a Battery Isolation Manager that monitors the battery voltage of both the chassis and house batteries over long periods of time. If it senses a charging voltage it connects the two batteries together. If the charge system is overburdened, it isolates both batteries. When batteries have reached a float charge state for (1) hour, the batteries are isolated to prevent overcharging.

It will reconnect if either battery drops to approximately 80% charge and the other is being charged. If batteries are not being charged they will be isolated to prevent an electrical draw in one system from depleting the other battery.

Auxiliary Start System (if so equipped)

Depending on your model, the Battery Boost switch (on the driver console) or the Auxiliary Start button (under the steering wheel on the lower dash) engages this solenoid and joins the house battery with the chassis battery to provide a “boost” to help start the motorhome if the chassis battery charge is low.

The auxiliary start switch can momentarily connect both the house and chassis batteries should the chassis battery become discharged.

To operate, depress either the “Aux. Start” switch (located on the front driver’s dash) or the Battery Boost switch on the driver console and hold it down. While the “Aux. Start” switch or Battery Boost switch is depressed use the ignition key to start the chassis engine. Release the “Aux. Start” switch (or Battery Boost switch) after the engine has started.



LOAD CENTER

The Load Center contains 12VDC fuses and 120VAC circuit breakers for almost all of the electrical appliances and circuits in the RV. The 120V main breaker may be located in this panel and will turn off all 120-volt power to the RV. Locations will vary by model. Refer to the diagram inside the load center for specific fuse assignments. Not all load centers will include a main breaker.

Motorhomes may have separate small panels for breakers and fuses. They are normally located in close proximity to each other typically in the bed platform.

The converter is also mounted separately (typically under the bed platform).

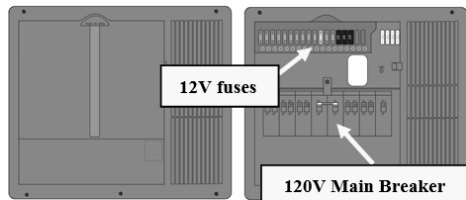

Typical Load Center Panel

Load Center Panel w/120 volt Main breaker – load center appearance and configuration may vary by model

AUTOMATIC TRANSFER SWITCH (ATS)

Your motorhome is equipped with an Automatic Transfer Switch. The ATS is microprocessor controlled and will automatically detect which power source is being used (generator or shore power) and allow power from that connection only. You will not have to plug and unplug power to the coach if you decide to run the generator.

If you plug into shore power, the ATS will pass power on through to the RV. If you start the generator, it will override the shore power input (called generator dominant) and supply the RV with electrical power from the generator. When the generator is shut down, shore power is again restored.

There may be a slight flicker of the lights when the ATS changes over from one to the other, but essentially power is constant and there is no real interruption of power.

The ATS will disconnect from shore power completely if the power coming in is not high enough quality (i.e. either low/high voltage, or low/high frequency).

When the generator is operating, it powers the inverter/charger which in turn functions as a multi-stage battery charger to charge the house auxiliary and chassis batteries.



NOTE: The diesel (or gas) generator requires 12-volt power from the house auxiliary batteries to start, and draws diesel fuel (or gas) to operate from the chassis fuel tank. If the fuel level in the chassis fuel tank drops to or below $\frac{1}{4}$ full, the generator will automatically shut "off" and cannot be re-started until the fuel tank is filled to above $\frac{1}{4}$ full.

120-VOLT CIRCUIT BREAKERS

The 120-volt AC circuit breakers located inside the load center protect all 120-volt wiring and components from circuit overloads and short circuits. Should a circuit overload or short circuit occur the circuit breaker protecting the affected circuit will "trip" preventing the flow of electricity through that circuit.

If a circuit breaker trips, shut "off" the appliance on that circuit (i.e., power converter etc.) and allow the circuit breaker to cool down for a brief period of time. After it cools down, reset the circuit breaker by moving its lever "off" and then back to the "on" position. If the circuit breaker re-trips or frequently trips, contact your dealer to have the electrical problem diagnosed and repaired.

A circuit breaker identification label is permanently attached to the inside surface of the 120-volt Load Center.



NOTE: Load Centers may not always include a main circuit breaker..

SECTION 6: ELECTRICAL SYSTEM



CAUTION

Circuit breakers and fuses will not offer complete protection of the electrical system in the event of power surge or voltage spike.

Replacement

Only replace circuit breakers with those of the same specified type, voltage, and current rating. **Never replace a circuit breaker with one listed at a higher amperage rating.** Please



WARNING

Replacement circuit breakers must be of the same voltage, amperage rating and type. Never use a higher rated replacement circuit breaker; doing so may cause a fire by overheating the RV wiring.

contact your dealer for repair assistance when replacing circuit breakers.

Maintenance

At the beginning of camping season, inspect the circuit breakers and replace as needed. Test by turning each circuit breaker “off” and back “on”. Circuit breakers are wearable parts and must be replaced as needed, as part of your RV maintenance. If you have any questions, consult your dealer.

A label is provided to explain the function of every 120-volt circuit breaker. This label is located on or near the appropriate load center or sub-panel and must remain permanently affixed to the recreation vehicle.

APPROXIMATE ELECTRICAL LOAD RATINGS

12 VOLT SYSTEM	
Exterior Entertainment Center	5-7 AMPS
Fan	1.5 AMPS
Furnace	12.0 AMPS
Generator Start	95.0 AMPS*
Illuminated Switch	.125 AMP
Inverter	variable
Leveling sSystem	95.0 AMPS*
LP Detector	.125 AMP
Light; Halogen	1.7 AMPS
Light; Vanity	4.2 AMPS
Lights; Aisle	1.0 AMP
Lights; Baggage Compartment / Shower	1.4 AMPS
Lights; Decorative Wall / Map / Porch	1.5 AMPS
Lights; Fluorescent Double -12"	2.0 AMPS
Lights; Fluorescent Double -18"	2.5 AMPS
Power Awning	10.0 AMPS
Power Vent	5.0 AMPS
Refrigerator	3.0 AMPS
Step Cover	10.0 AMPS
TV Plate/Antenna Booster	1.0 AMP
Water Heater	6.0 AMPS
Water Pump	7.0 AMPS

*Momentary Load

12 Volts: Labeled watts divided by 12 = Power consumed in AMPS

120 VOLT SYSTEM	
Air Conditioner	18 AMPS
Coffee Maker	6-12 AMPS
Converter (each)	8 AMPS
DVD System	3 AMPS
Fireplace	12 AMPS
Hair Dryer or Curling Iron	10-14 AMPS
Microwave	12 AMPS
Refrigerator	6 AMPS
Satellite Receiver	2 AMPS
TV	2-4 AMPS
Vacuum Cleaner	8 AMPS
Washer/Dryer	12 AMPS
Water Heater	12 AMPS

120 Volts: Labeled watts divided by 120 = Power consumed in AMPS

SECTION 6: ELECTRICAL SYSTEM

120-VOLT (30 AMP) AC SYSTEM (IF SO EQUIPPED)

The 30 amp 120-volt 60hz AC electrical system is designed to operate on 1 leg of 120-volt power at a maximum current flow of 30 amperes.

Exposure to voltages higher or lower than a nominal 120-volts will damage or shorten the service life of the electrical system and appliances. The 30 amp 120-volt 60hz AC electrical system can be powered by the 120-volt 60hz utilities found in RV campgrounds or by 120-volt 60hz generator power.

The following electrical components will only operate when your recreation vehicle is connected to shore or generator power: 120 to 12-volt power converter, air conditioner, refrigerator, microwave oven, television(s), home theater system(s), electric water heater, washer, dryer, fireplace, and appliances plugged into convenience receptacles.

WARNING

- Make certain the external power source you connect the power cord to is a properly wired **30 amp NEMA TT-30** RV receptacle and not 240-volt AC. **PLUG INTO 30-AMP SERVICE ONLY.**
- Circuit breakers and fuses will not offer complete protection of the electrical system in the event of power surge or voltage spike.

30-amp Power Cord (if so equipped)

WARNING

- Do not hook up the power cord to any receptacle **until** you have verified proper polarity and grounding. Polarity indicators can be purchased in most electrical and hardware stores.
- Do not use any cheater plug, adapter or extension cord to reconfigure incoming AC power or break the continuity of the circuit connected to the grounding pin.
- Do not connect the power cord into an outlet that is not grounded, or adapt the power cord plug to connect it to a receptacle for which it is not designed.
- Do not remove the grounding pin to connect to a non-grounded receptacle. Removal of the ground pin disables an important safety feature designed to prevent shock and electrocution hazards.
- Do not connect the power cord to an extension cord. Use of an improper extension cord will cause overheating of the cord as well as potentially causing premature failure of the AC equipment.

It is the responsibility of the owner of the electrical receptacle to ensure that the receptacle is properly wired and grounded. Reverse polarity and/or improper grounding of your recreation vehicle can cause personal injury or death.

The 30-amp external utility power cord is commonly referred to as the “shore” power cord. It is designed to mate and properly function with 30-amp “shore” power receptacles available at most campgrounds.

The shore power cord is designed to continuously carry the 30-amp current flow required to power each leg of the electrical system. It also creates a critical ground connection between the vehicle electrical system and the campground shore power receptacle.

Always test the external power source (i.e., the campsite power receptacle or electrical box) with a ground monitor before connecting your power cord to it. If the ground monitor indicates ‘reverse polarity’ or an ‘open ground’ **DO NOT** connect the power cord.

Regularly inspect the shore power cord for cuts, cracks, worn insulation and other damage. Have the power cord replaced immediately if problems exist.

Calculating 30 AMP Electrical Load (if so equipped)

When connecting appliances to the electrical system, 120-volt power usage is limited to a total of 30 amps. Operating appliances collectively places an added load on your 120-volt electrical system.

An unintentional “trip” of a circuit breaker may occur if you overload the recreation vehicle and/or campground electrical system. The amperage rating of individual appliances can be calculated by dividing appliance wattage consumed (normally listed on the appliance) by nominal design voltage (120 for a 120-volt appliance). For example: 1200 watts divided by 120-volts equals 10 amps.

GENERATOR

Your motorhome may be equipped with an LP or diesel powered generator. In certain gasoline engine motorhomes, the generator will be gasoline powered as well. The generator in your motorhome produces 120/240-volt power compatible with the motorhome electrical system. It can be used to power the entire motorhome when 120/240-volt shore power is not available.

Automatic Generator Start (AGS)

Vegatouch systems include an AGS screen to program your generator to automatically start and stop at specified times. The AGS button is located on the Home screen of the Vega Touch display. Please refer to your *Vegatouch User Guide* in your warranty portfolio.

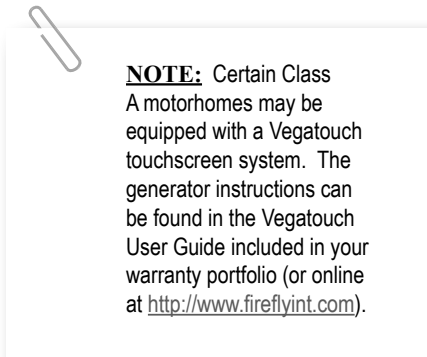

Vegatouch AGS Button

Transfer switch

The generator interfaces with the 120/240-volt electrical system through a transfer switch that automatically switches between available shore power and generator power. The transfer switch does not require any manual operation. (For more information see the *Automatic Transfer Switch (ATS)* section)

SECTION 6: ELECTRICAL SYSTEM



NOTE: The diesel (or gas) generator requires 12-volt power from the house auxiliary batteries to start, and draws diesel fuel (or gas) to operate from the chassis fuel tank. If the fuel level in the chassis fuel tank drops to or below $\frac{1}{4}$ full, the generator will automatically shut “off” and cannot be re-started until the fuel tank is filled to above $\frac{1}{4}$ full.

Before Starting the Generator

1. Make sure the carbon monoxide detector is working.
2. Turn “off” air conditioners and all other 120-volt appliances.
3. Check for fuel, exhaust and coolant leaks.

STOP the generator immediately if there is a fuel, exhaust or coolant leak. Have all leaks repaired prior to placing the generator back in service.

WARNING

CARBON MONOXIDE IS DEADLY! Do not run the generator when your motorhome is indoors or in a confined space. Asphyxiation or carbon monoxide poisoning hazards exist whenever generator exhaust gasses can accumulate.

MOVING PARTS AND ELECTRICITY can cause severe personal injury or death. To reduce exposure to these hazards, **always disable AGS (if so equipped) before:**

- Sleeping in vehicle, unless vehicle has a working CARBON MONOXIDE detector.
- Parking vehicle in garage or confined space.
- Parking vehicle for storage.
- Servicing vehicle for storage.
- Servicing generator.
- Servicing batteries.
- Servicing appliances or electrical systems.
- Fueling the vehicle.

DO NOT run the generator or use the AGS AUTO ON or QUIET ON modes (if so equipped) when your RV is indoors or in a confined space. Asphyxiation or carbon monoxide poisoning hazards exist whenever generator exhaust gasses can accumulate.

Maintenance

During periods of extended storage:

1. Add a diesel fuel additive to the chassis fuel tank to prevent algae growth. (only if you have a diesel fuel generator)
2. Completely fill the chassis diesel fuel tank to prevent water condensation and rust in the tank. (only with a diesel fueled generator)
3. Cover the end of the generator exhaust pipe with screen to prevent bug and rodent intrusion.

With the exception of simple items, such as normal maintenance (i.e., oil changes, etc.), all service work should be done by an authorized repair facility. Improper adjustments can damage the generator and electrical appliances and can result in a safety hazard. **Follow the generator owner's manual for maintenance intervals and recommendations.**

Exercising Your Generator – When storing the generator for extended periods of time, it is important to run the generator regularly to keep everything in good working order. Lack of exercise can cause moisture build-up in the fuel system resulting in poor performance.

For more information on generator operation and maintenance, refer to the generator owner's manual.

CAUTION

Excessive usage can overheat and damage the generator starter motor. Do not engage the starter motor for more than 20 seconds at a time. If the generator doesn't start after the first attempt, wait at least two minutes before beginning another start sequence. If the generator does not start after a third attempt, refer to the generator owner's manual for additional information.

STARTING THE GENERATOR

If your motorhome is equipped with a generator, there will be a control switch to turn it ON and OFF at the Command Center panel inside the RV. There may also be secondary switches located at the dash, or on the generator itself. There is also a digital hour meter that will turn on when the generator is started. An LED above the start switch will light when the generator is running.

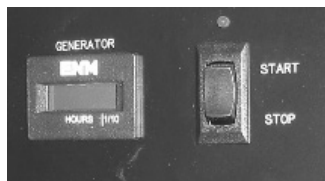

To Manually Start the Generator

(Manual switches located on the Command Center Panel)

1. At either "START/STOP" switch, press and hold the upper portion of the switch to start the generator. Depending on the outside temperature the start process can take up to 15 seconds. Once the generator starts running, release the "START/STOP" switch.
2. For better performance and engine life, especially in colder weather, let the generator engine warm up for two minutes before turning "on" 120-volt appliances.

For more information on generator operation and maintenance, refer to the manufacturer's owner's manual.

Automatic Generator Start (AGS) (if so equipped)

(Controls are built into the Vega Touch touchscreen system)

Class A motorhomes and certain Class C motorhomes may be equipped with an Automatic Generator Start system (AGS). AGS is not currently available on towable models.

When enabled, the Automatic Generator Start system will automatically start and stop the generator according to operator or factory pre-selected parameters.

The Magnum AGS Start section or the *Vegatouch User Guide* (in your warranty packet) will give more detailed instructions about Automatic Generator Start depending on your model.

SECTION 6: ELECTRICAL SYSTEM

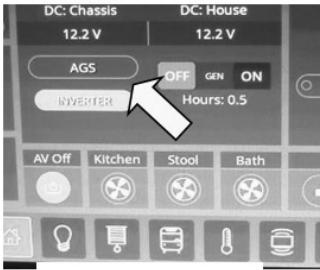

Auto Gen Start on Vegatouch Screen



Auto Gen Start Settings Vegatouch Screen

SOLAR PREP (IF SO EQUIPPED)

Your motorhome may be equipped with a roof mount solar panel quick connection. This allows a (customer purchased) solar panel to be installed permanently on the roof. Installation will consist of the solar panel(s), regulator and wiring/fusing between the regulator and batteries. There are no other solar plugs for portable solar panels on the vehicle.

The (black ABS) solar prep box is located in a basement compartment of the RV and is marked with a solar prep label (indicating wire colors and polarity). There is also an additional label indicating the RV is wired for solar.

When connected, the solar panel will supply power to the battery, the battery will supply power to the converter, and the converter will supply power to all the 12V systems as needed.

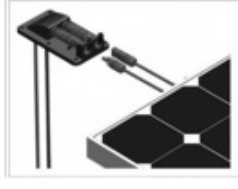

REPLACING LIGHT BULBS

Before replacing a bulb, be sure the light is off. Do not touch the glass part of the new bulb with your bare fingers. The skin oil left on the glass will evaporate when the bulb gets hot, the vapor will condense on the reflector and it will dim the surface.

Replacement light bulbs must be of the type, voltage and wattage listed on the lamp fixture. Use of incorrectly sized bulbs can overload lamp circuits and may create a fire hazard by overheating the fixture.

DIESEL FUEL AND FILL

It is critical to understand the danger associated with fuel. Take time to become educated about the property of fuel and use it safely.

 **DANGER**

Automotive fuels can cause serious injury or death if misused or mishandled. If you have further questions, consult your dealer or Customer Service for assistance.

- Always shut OFF the vehicle engine while refueling.
- Do not bring or store fuel or other flammable liquids inside the motorhome because a fire or explosion may result.
- Before refueling, extinguish all smoking materials and any open flames.
- Before refueling, always turn OFF all spark producing appliances (i.e., water heaters, furnaces, etc.).
- Do not overfill the fuel tank(s). The pressure in an overfilled fuel tank may cause leakage and lead to fuel spray and/or fire.
- Fuel spills represent a serious fire hazard, and should be cleaned up immediately.
- Never restart an engine or re-light any pilot lights while raw fuel is present.

FAILURE TO COMPLY COULD RESULT IN FIRE, DEATH OR SERIOUS INJURY.

Fuel Selection

Use diesel fuel only. The diesel generator (if so equipped) is also fueled by the same system used to fuel the motorhome chassis engine. Consider the fuel requirements of the generator (if so equipped) when making a decision on the type of fuel to use.

DEF Fluid

Diesel engines (since 2010) require the use of DEF fluid (Diesel Exhaust Fluid) to aid in burning particulate matter in the exhaust and reduce emissions to nitrogen and water. This DEF fluid is kept in a separate heated tank and is required for the normal operation of the diesel engine. DEF tank is typically located in one of the exterior compartments and the tank will have a blue cap with “DEF” written on it. There will be a series of warnings at the dash before running out of DEF fluid. If the vehicle is allowed to run out of DEF fluid, engine power is intentionally reduced and speed will be limited to 5 MPH until the tank is re-filled.



NOTE: If your motorhome is equipped with a diesel generator, check the diesel generator and chassis manufacturer’s information to help you determine the type of diesel fuel best suited for this dual application.

 **CAUTION**

If you spill fuel on the motorhome, clean it up immediately. Fuel can dull or soften paint and damage other surfaces.

SECTION 7: FUEL & PROPANE SYSTEM



NOTE: If your motorhome is equipped with an Aqua-Hot Heating system, it may be fueled from either an LP tank or from the chassis diesel tank(s). If fueled from the chassis diesel tank(s) the fuel consumption of this system should be considered when planning your fuel supply to insure you will have adequate fuel to run your system. The fuel feed for the Aqua-Hot system is positioned in the fuel tank so that when the fuel supply for the system is exhausted, you will still have fuel remaining to operate your motorhome. For additional information refer to the Aqua-Hot owner's manual.

FUEL SAFETY

DANGER

Automotive fuels can cause serious injury or death if misused or mishandled. If you have further questions, consult your dealer or Customer Service for assistance.

- Always shut OFF the vehicle engine while refueling.**
- Do not bring or store fuel or other flammable liquids inside the motorhome because a fire or explosion may result.
- Before refueling, extinguish all smoking materials and any open flames.
- Before refueling, always turn OFF all spark producing appliances (i.e., water heaters, furnaces, etc.).
- Do not overfill the fuel tank(s). The pressure in an overfilled fuel tank may cause leakage and lead to fuel spray and/or fire.
- Fuel spills represent a serious fire hazard, and should be cleaned up immediately.
- Never restart an engine or re-light any pilot lights while raw fuel is present.

FAILURE TO COMPLY COULD RESULT IN FIRE, DEATH OR SERIOUS INJURY.

Fuel Selection

The generator is also fueled by the same system used to fuel the chassis engine. Check the generator manufacturer and the chassis manufacturer information to help determine the type of fuel best suited for this dual application.

Fuel Filler Cap

WARNING

Do not replace the fuel fill cap with one of a different type. Only use a cap specified for your motorhome. Use of a substitute cap may create excessive fuel system pressure, resulting in fuel station damage and improper operation in a collision.

Remove the fuel filler cap by slowly turning it counterclockwise and waiting for any “hiss” noise to stop. Then unscrew the cap all the way. To close the fuel filler cap, securely turn the cap clockwise until you hear clicking sounds.

Filling the Fuel Tank

If you spill fuel on the motorhome, clean it up immediately. Fuel can dull or soften paint and damage other surfaces. Use care when fueling your motorhome.

EXHAUST GAS FUMES

WARNING

- Avoid inhaling exhaust gases as they contain carbon monoxide, which is a potentially toxic gas that is colorless and odorless.
- If you are in a parked motorhome with either the engine running or the generator running there is a potential for exhaust fumes to filter back into the motorhome.

To avoid breathing exhaust gases, follow these precautions:

- Do not run the engine in confined areas, such as a closed garage, any longer than needed to move your motorhome in or out of the area.
- Windows should be closed while driving or running the generator (if so equipped) to avoid drawing dangerous exhaust gases into the motorhome.
- If you suspect that exhaust fumes are entering the passenger compartment, have the cause determined and corrected as soon as possible.

If you must drive under these circumstances, close all the windows, and adjust the heating or cooling system to force outside air into the motorhome (set the blower on high speed).

The best protection against carbon monoxide entry into the motorhome is a properly maintained ventilation system and an active carbon monoxide detector. To allow for proper operation of the motorhome ventilation system, keep the ventilation inlet grill(s) clear of snow, leaves or other obstructions at all times.

Maintenance

It is recommended that the exhaust system and vehicle body be inspected by a qualified motorhome service center:

- Each time the engine is ready for an oil change.
- Whenever a change in the sound of the exhaust is noticed.
- Whenever the exhaust system, underbody or rear of the vehicle is damaged.

For more information refer to your Chassis Guide.

PROPANE GAS SYSTEM (IF SO EQUIPPED)

Propane or LP (liquefied petroleum) gas is an efficient form of energy when proper handling and safety precautions are observed. The propane system in your motorhome furnishes the fuel for cooking, heating, hot water and can be an alternative energy source for refrigeration. Propane is heavier than air and tends to flow to lower areas and will sometimes pocket in these low areas, such as the floor. Your motorhome is equipped with a propane alarm (refer to *Safety Precautions*, Combination Carbon Monoxide (CO)/Propane Alarm).

SECTION 7: FUEL & PROPANE SYSTEM

WARNING

Propane cylinders should not be placed or stored inside the vehicle. LP-gas cylinders are equipped with safety devices that relieve pressure by discharging gas into the atmosphere.

The propane fuel system is comprised of numerous components such as the propane container, hoses, the propane gas regulator, piping and copper tubing to each appliance.



Your motorhome has been carefully tested at the factory and by your selling dealer for leakage, travel vibrations can loosen fittings. Have the vehicle propane system checked at all connections soon after the purchase of your vehicle, and after the initial filling of the propane tanks.

Continued periodic checks of the propane system at 5,000 miles of travel (or at least once a year), by a qualified propane service representative as part of your normal maintenance is recommended. Hand tighten the LP gas system valves only, do not use a wrench or pliers as over tightening may damage the valve seals and cause them to leak.



NOTE: All propane lines have been checked with air pressure at the time of manufacture. Dealers are required to recheck and adjust pressure before retail delivery.

The following label should be kept permanently affixed to the motorhome:

 DANGER
ALL PILOT LIGHTS, APPLIANCES, AND THEIR IGNITORS (SEE OPERATING INSTRUCTIONS) SHALL BE TURNED OFF BEFORE REFUELING OF MOTOR FUEL TANKS AND/ OR PROPANE CONTAINERS. FAILURE TO COMPLY COULD RESULT IN DEATH OR SERIOUS INJURY.
 WARNING
DO NOT FILL PROPANE CONTAINER(S) TO MORE THAN 80 PERCENT OF CAPACITY. FAILURE TO COMPLY COULD RESULT <u>IN DEATH OR SERIOUS INJURY.</u>
 CAUTION
THIS PIPING SYSTEM IS DESIGNED FOR USE WITH PROPANE ONLY. DO NOT CONNECT NATURAL GAS TO THIS SYSTEM. Securely cap this inlet when not connected for use. After turning on propane, except after normal cylinder replacement, test propane piping and connection to appliances for leakage with soapy water or bubble solution. Do not use products <u>that contain ammonia or chlorine.</u>
DD-37

Propane Label

Propane Gas Container

Propane is a true gas compressed into a liquid form. As the fuel is released from the container, it changes to vapor which is then used for the operation of the appliances. Propane will not run through the appliances in the liquid state.

NOTE: Tanks are to be installed, fueled and maintained in accordance to State and Local codes, rules, regulations or laws.

A permanently mounted A.S.M.E. approved propane container is located under the floor of the motorhome.

Propane expands 1½ percent for every ten degrees of increase in temperature. It is imperative to leave sufficient space inside the container to allow for natural expansion of gas during warmer weather.

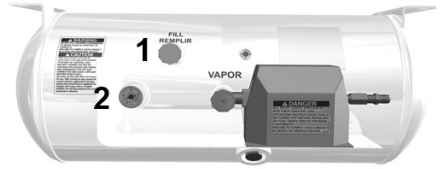

1-Propane fill valve; 2-Propane gauge
ASME tank

Servicing or Filling

⚠ WARNING

- Always shut OFF the engine while refueling.** Do not smoke and do not operate other ignition sources while refueling.
- When the propane container is disconnected from the main supply hose and the P.O.L. connection, install the P.O.L. plastic cap that is attached to the container.**
- If you suspect your propane container has been overfilled, contact your dealer or a qualified propane technician for assistance immediately.** Do not attempt to service a propane container overfill yourself.

Because the container is not removable, the motorhome will need to be driven to a qualified propane facility for servicing or filling.

Only the authorized gas service technician(s) should be near the motorhome while the propane tank is being filled. The new propane container must be carefully purged for proper appliance performance and operation. The propane tank must **NEVER BE OVERFILLED.**

Replace all protective covers and caps on the propane system and/or container after filling. Make sure the valve is closed and the compartment door is securely latched.

LP Gas Container Overfill

Never allow your propane tank to be filled above the maximum safe level as indicated by the fixed liquid level gauge.

Do not allow the visible gauge to be used for filling. Overfilling the propane container above the liquid capacity indicated on the container, could allow liquid propane to enter the system that is designed for vapor only creating a hazardous condition.

SECTION 7: FUEL & PROPANE SYSTEM

The following warning label has been placed by the propane container.

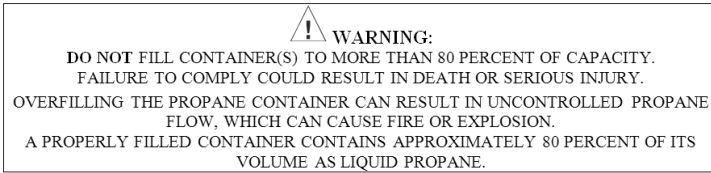

Propane System Label

Refer to your Warranty Packet for more information on the LP gas system components.

Propane Regulator

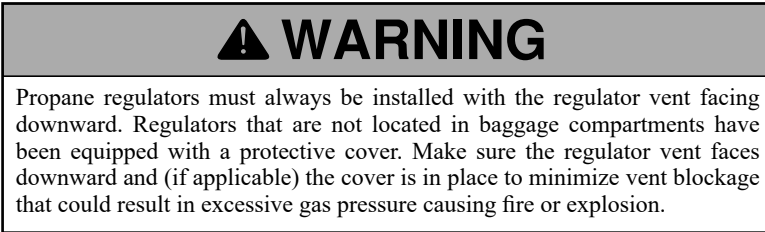

NOTE: Regulator appearance and type may vary by model.

Single stage regulator

Some models are equipped with a single stage regulator.

Two stage regulator

The two-stage regulator has the only moving components in the propane system. Its sole function is to reduce the pressure from the propane containers to a safe and consistent low operating pressure. The first stage reduces the container pressure to 10-13 lbs. The second stage reduces the 10-13 lbs. of pressure further to an operating pressure of 11" W.C. (water column) or 6.35 oz. of outlet pressure to your appliances.

The second stage is adjustable and will need to be adjusted by your dealer or qualified propane service technician for optimum performance (this adjustment should always be made with a properly calibrated manometer).

If the pressure is too high, it affects performance and safety; if the pressure is too low, your appliances will not operate correctly.

If your recreation vehicle is equipped with the "automatic" two-stage regulator, with both cylinders full of propane, turn the lever on the regulator towards the cylinder you wish to use first. This will now be the "supply" cylinder and the other the "reserve". Slowly open both cylinder valves. The indicator on top of the regulator will turn bright green. When the cylinder becomes empty, the indicator will change to bright orange. Now turn the regulator lever to the side of the "reserve" cylinder and the green signal should return. You may now remove the empty cylinder to have it refilled without interrupting the flow from the full bottle. After filling the cylinder, connect the pigtail hose and slowly open the bottle valve.

PROPANE USE AND SAFETY

Propane is a colorless and odorless gas that, in the liquefied state, resembles water. An odorant (usually a sulfur compound) is added as a warning agent. If you smell propane within the vehicle, quickly and carefully perform the procedure listed on the propane system label. This label has been placed in the vehicle near the range, for models equipped with a propane system. When propane container is low, occasionally there may be a concentration of an onion or garlic-like odor, which can be mistaken for a propane gas leak. After the propane container has been refueled, the odor will usually disappear. If not, turn off the valve(s) and have the propane system inspected by your dealer or qualified propane service representative.

⚠ DANGER

- IF YOU SMELL PROPANE**
1. Extinguish any open flames, pilot lights and all smoking materials.
 2. Shut off the propane supply at the container valve(s) or propane supply connection.
 3. Do not touch electrical switches.
 4. Open doors and other ventilating openings.
 5. Leave the area until odor clears.
 6. Have the propane system checked and leakage source corrected before using again.

Ignition of flammable vapors could lead to a fire or explosion and result death of serious injury.

Propane Leak Test

Leaks may be found easily with a soapy water solution.

Do not use a solution containing ammonia or chlorine when locating leaks. These products are corrosive to copper gas lines and brass fittings, which could result in deterioration of the copper and brass components.

Apply the soapy solution to the outside of the gas piping fittings. If a leak is present, the soapy solution will “bubble” at the leak point. If a leak is indicated, shut off the propane system valve(s) and contact your dealer or qualified propane service representative immediately.

Propane System Label

⚠ DANGER

Never use an open flame to test for a propane leak. Do not check for leaks using products that contain ammonia or chlorine; these products can cause cracks to form on the metal tubing and brass fittings

Using The Propane System

Use the following steps for propane operation:

1. Close ALL burner valves, controls and pilot light valves.
2. Open the main valve in the propane tank slowly to avoid a fast rush of propane vapor through the excess flow valve causing propane “freeze-up.” Should you experience propane “freeze-up,” close the main valve and wait 15 minutes before trying again.
3. Listen carefully as propane begins to flow. If a hissing noise is heard for more than one or two seconds, close the main valve and contact your recreation vehicle dealer to have the propane system tested.
4. **Light the appliances as needed and directed in the appropriate appliance manufacturer’s owner manual located in the Warranty Packet.**

Keep the propane container valves closed at all times unless you are using the propane gas system or are having the propane container filled.

Make sure that you read and fully understand ALL safety requirements for handling and operation of the propane system.

SECTION 7: FUEL & PROPANE SYSTEM

The propane system must be handled with care. If you have any questions or concerns, consult with your dealer and/or the specific appliance manufacturer.

If you have double cylinders on your recreation vehicle, use only one at a time. Otherwise, the propane supply will be drawn equally from both cylinders until the supply has been totally exhausted. Using one cylinder until it is empty, then using the second cylinder will allow you to fill the empty cylinder at your convenience without running totally out of propane.

Cooking With Propane Gas

WARNING

- Do not turn gas range burner controls to ON and allow gas to escape before lighting.
- Do not use portable fuel burning equipment (i.e., wood and charcoal grills or stoves) inside the recreation vehicle.

Unlike homes, the amount of oxygen supply is limited due to the size of the recreation vehicle. Proper ventilation when using the cooking appliance(s) will help you avoid the danger of asphyxiation.

It is especially important that cooking appliances not be used for comfort heating, as the danger of asphyxiation is greater when the appliance is used for long periods of time. FAILURE TO COMPLY MAY RESULT IN DEATH OR SERIOUS INJURY.

These warning labels are located in the cooking area to remind the user to provide an adequate supply of fresh air for combustion.

DANGER

Do not use gas cooking appliances for comfort heating. Can lead to carbon monoxide poisoning, which can lead to death or serious injury.

WARNING

Gas cooking appliances need fresh air for safe operation. Before operating: Open vents or windows slightly or turn on exhaust fans prior to using cooking appliance. Gas flames consume oxygen, which should be replaced to ensure proper combustion. Improper use can result in death or serious injury.

Cooking / Comfort Heating Label

TO ENSURE A SUPPLY OF FRESH AIR TO OCCUPANTS, OPEN VENTILATORS WHEN FUEL BURNING RANGE, FUEL BURNING CARRY-ON APPLIANCE, AND/OR FUEL BURNING LIGHTS ARE IN OPERATION. COOKING APPLIANCES SHOULD NOT BE USED FOR SPACE HEATING PURPOSES.

DE MANIÈRE À ASSURER UNE ALIMENTATION EN AIR FRAIS AUX OCCUPANTS, OUVRIER LES VENTILATEURS LORSQUE LA CUISINIÈRE, LES APPAREILS DE CHAUFFAGE PORTABLES ET/OU LES LAMPES DE COMBUSTION D'HUILE SONT EN FONCTIONNEMENT. LES APPAREILS DE CUISSON NE DOIVENT PAS SERVIR AU CHAUFFAGE DES LOCAUX.

JA-110

Ensure a supply of fresh air (Canada units only)

Calculating Propane Gas Usage

Most RV gas appliances are operated intermittently, and each has a different BTU rating. You will need to consider this when planning your propane supply and consumption. Unless there is heavy use of hot water, the water heater consumption of propane is minimal. During cool temperature or high wind conditions, furnace consumption can be extremely high.

To calculate your propane supply, take the BTU ratings for your propane appliances and divide that into the BTU availability. Each gallon of propane gas (3.785 liters) produces about 91,500 BTU's (96,528 kilojoules) of heat energy.

Propane consumption chart

The following chart provides average propane consumption information.

Appliance	Average BTU Consumption per Hour	Kilojoules/Hour
Water Heater	8,800	9,280
Refrigerator	1,200 – 1,500	1,270 – 1,580
Furnace	35,000 – 40,000	36,930 – 42,200
Range/oven	7,100	7,490
Range, rear burner	6,500	6,860
Range, front burner	9,000	9,490
Outside Grill	10,000	10,550

Traveling With Propane



NOTE: Some states prohibit propane appliances to be operated during travel, especially in underground tunnels. Make sure you know the laws for the areas where you travel.

Use care when fueling your motor fuel tanks and/or propane containers. Make certain your propane tank is properly fastened in place. This label should be kept permanently affixed to your recreation vehicle.

<p>▲ DANGER ALL PILOT LIGHTS, APPLIANCES AND THEIR IGNITORS (SEE OPERATING INSTRUCTIONS) SHALL BE TURNED OFF BEFORE REFUELING OF MOTOR FUEL TANKS AND/OR PROPANE CONTAINERS. FAILURE TO COMPLY COULD RESULT IN DEATH OR SERIOUS INJURY. <small>AD-05</small></p>

Refueling Warning Label

SECTION 7: FUEL & PROPANE SYSTEM

Notes:

PLUMBING SYSTEM

There are two different water systems in your recreation vehicle:

- The fresh water system consists of the fresh water holding tank, faucets and connections, water pump, outside shower assembly (if so equipped), water heater, tub/shower, and water purification system (if so equipped).
- The waste water system consists of the waste water and sewage holding tank(s), drains and toilet.

Plumbing System Maintenance

- Check all fittings, pressure and waste, for leaks before each trip or before vehicle storage as part of your normal maintenance:
- Inspect all faucets, the water purification system (optional) and sink connections (including drain baskets or filters).
- Inspect connections at the water pump and water heater.
- At the end of every trip, you should drain any unused water from the fresh water system.
- All water contains contaminant and mineral particles that can cause fresh water system odors. Untreated well water is a major source of water system odors.
- The fresh water (potable water) system needs periodic sanitization and winterization to take care of all the components within the plumbing system and help discourage the growth of bacteria and other organisms that can contaminate the water supply.

Typically, there are labels affixed to the exterior of the recreation vehicle sidewall that indicate the locations of the water system drains and fills. Be aware some drain valves may be located inside the vehicle (once the exterior label is found, go inside to find the drain corresponding location).

MONITOR PANEL

Monitor panel locations may vary by model. Typical locations are on the command center panel, on an interior wall, or on the exterior utility center.

It allows you to monitor the fresh water, grey water, black water and auxiliary battery levels. These functions are controlled using the tact switches. The monitor panel operates on 12-volt DC power supplied by either the converter or auxiliary battery. No power is drawn from the battery unless a switch is pushed or turned ON. Fuses for the monitor panel are located in the load center. Refer to the manufacturer's operators manual for additional information.

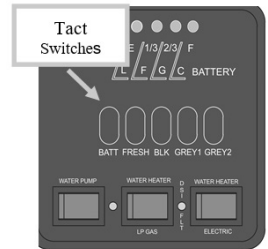

Monitor Panel

NOTE: If your RV has secondary black or gray tanks, there may also be an additional tank monitor, located elsewhere in your RV. It is typically labeled as a convenience center.

SECTION 8: PLUMBING SYSTEM

Operation

Press only one tact switch at a time. As you push either the FRESH, BLK GREY1 or GREY2 switch, one or more LED lights will illuminate (from left to right) indicating the content level for that tank. When pushing the "BATT" switch, the LED lights illuminate from left (lowest) to right (highest) to indicate the estimated auxiliary battery condition.

NOTE: When using shore power all 4 LEDs will light. If disconnected from shore power, 3 LEDs will light to indicate a full charge (4th LED may blink).

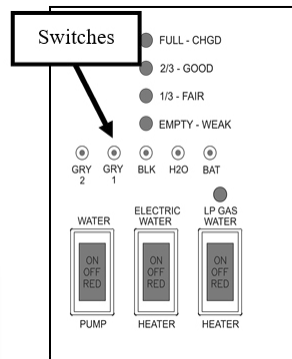

Command Center
(monitor panel appearance and components may vary)

The LEDs on the panel indicate the following:

C = Charge at 12.7 volts

G = Good at 12.1 volts

F = Fair at 11.6 volts

L = Low at 6.0 volts

The **water pump switch (if so equipped)** may be located on the monitor panel, the utility center or both. When the water pump switch is ON (it will light up), the water pump will run until it reaches 45 lbs. of pressure. It will recycle when pressure drops. Turn the switch OFF when the water pump is not being used.

The **water heater switch(s) (if so equipped)** are located on the monitor panel, and will light up when turned on. The "LP GAS" water heater switch (12V) enables propane operation of the water heater, and the "ELECTRIC" switch (120V) enables electric operation of the water heater. Normally both switches should be turned on to provide the fastest hot water recovery time. The water heater can be operated in electric only or gas only modes by pressing each switch independently. If the RV is equipped with a tankless water heater, there will be only an LP Gas switch on the command center panel.

DSI FLT - Direct Spark Ignition Fault (if so equipped): This light located between the water heater switches will indicate a problem with the LP portion of the water heater. When the LP GAS switch is turned on, the light will blink quickly 3 times and the water heater will ignite. The light will then remain off. If the light comes on and stays on, it indicates the gas side of the water heater has not fired and there is a problem with the igniter.

FRESH WATER SYSTEM

All water contains contaminant and mineral particles that can cause fresh water system odors. Untreated well water is a major source of water system odors. The fresh water (potable water) system needs periodic sanitization and winterization to take care of all the components in the plumbing system to discourage the growth of bacteria and other organisms that can contaminate the water supply.

 WARNING

- DO NOT drink water deemed microbiologically unsafe or of unknown quality.
- Never travel with full fresh, black or grey water holding tanks.

Water Pressure Regulator (customer supplied)

 CAUTION

A water pressure regulator is recommended to prevent damage to the plumbing system or components. To prevent damage when using the city water connection, a 45 lb. (315 KPa) rated water pressure regulator is recommended.

Excessive pressure from the water supply source may be encountered in some parks, especially in mountain regions when using the fresh water inlet or black tank flush. Water pressure regulators are available to protect your recreational vehicles plumbing system against such high pressure.

Fresh Water Holding Tank

There may be several ways to fill the fresh water tank depending on the model. For details of each method, refer to the *Fresh Water Connections* or the *Utility Center (if so equipped)* sections. There are plastic overflow tubes in the fresh water holding tank which allow water to flow out of the water tank (see *City Water Fill*). Occasionally, you may see water coming from the overflow tubes when the fresh water holding tank is filled. This is normal and can be a result of the recreation vehicle being parked on an incline, or the motion caused by starting or stopping during travel.

 CAUTION

- Do not cap, block or modify the fresh water tank overflow tubes in any way. Enough water pressure can build up during the filling process to damage the plumbing system if the overflow tubes are obstructed.
- Be careful not to overfill the fresh water holding tank. It can pressurize the tank, causing leakage and water damage and void the warranty. DO NOT leave the tank unattended while filling.

12-Volt Water Pump and Switch

When you want to use water in your recreation vehicle and it is not hooked up to city water, you will need sufficient 12-volt DC power to run the water pump.

Once activated, the water pump (also known as the demand pump) will self-prime, and provide water. The pump is designed for **intermittent use only**. Using the pump continuously or with high pressure will shorten the life of the pump and is not covered in your warranty.

Periodically check the in-line water pump strainer for accumulated debris. To clean, shut off the water pump, unscrew the clear cap, remove the re-useable metal strainer and clear any debris, then reinstall.

For additional information on the care and operation of the pump, read the safety and operating information in the pump manufacturer's owner's manual.

SECTION 8: PLUMBING SYSTEM

Water Pump Switch (if so equipped)

Most water pump switches illuminate when the water pump is activated. In most models, the (red) pump switch is located on the monitor panel or the utility center. When the water pump switch is ON the pump runs until 45 lbs. of pressure has been achieved. The red light will stay on. The water pump automatically recycles when pressure drops. Some cycling may occur depending on the volume of water being released. Turn the water pump switch OFF when it is not in use.



NOTE: In some models the water pump switch will be a black rocker switch located near the sink cabinet

The water pump switch should be in the OFF position when the RV is left unattended for any amount of time. If something would happen to the water system, this may help limit water damage to a smaller area.

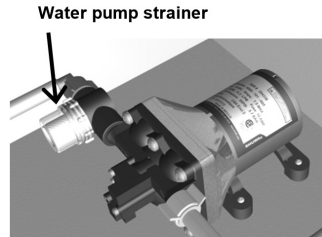

Water Pump Strainer

WATER PURIFICATION SYSTEM (IF SO EQUIPPED)

If equipped with a water purification system:

- If the water supply has not been used for some time, allow the water to flow for several minutes to flush the system.
- Filters should be replaced at the beginning of each camping season or if they have come into contact with contaminated water.**
- When not in use, the water filter cartridge should be stored out of freezing temperatures. RV antifreeze will damage the water filter cartridge.
- Filter canister is typically located in a compartment behind the utility center.

To Replace Canister Filter Cartridge:

1. Turn off water supply using two valves located on the water lines on each side of the canister. Water pump should be OFF.
2. Place drip pan below filter housing to catch any spillage.
3. Press the red button on top of the filter housing to release pressure.
4. Using a spanner wrench, rotate the filter housing. Unscrew the housing completely, dump water out and remove the filter (dispose of the old filter properly).
5. Clean the inside of the filter housing with mild detergent. Thoroughly rinse and wipe clean.
6. Remove the O-ring from the groove in the housing and wipe clean. Recoat with petroleum jelly.
7. Replace the O-ring in the groove, making sure it is properly seated.

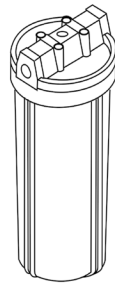

Filter Housing

8. Install the new filter cartridge.
9. Replace the canister housing (hand tighten is normally sufficient).
10. Turn on the water supply, turn the pump ON, open a faucet and check for leaks. Turn the pump OFF afterwards.

Each new recreational vehicle is winterized with RV antifreeze before it is shipped to the dealer. To use the water purification system: full system canister water lines need to be flushed of antifreeze and then the filter installed in the canister before use.

Refer to the manufacturer's owner's manual and the label on the water filter cartridge for further information.



NOTE: There is no bypass feature on a canister style water filter. The water filter must be removed **before sanitizing or winterizing** the RV.

CAUTION

- Do not allow water in the canister housing to freeze.
- Remove the filter before using anti-freeze to winterize the system or chlorine solution to sanitize the system.
- Flush canister housing thoroughly before it is put back into service after winterizing or sanitizing.
- For best results replace filter every 6-12 months.
- Do not use carbon cartridges where water is microbiologically unsafe or of unknown quality.
- Maximum operating pressure is 125 psi (8.75 bar).
- Maximum water temperature is 125° F (52° C).

DRAINING THE FRESH WATER SYSTEM

Water tanks may be drained through a valve located near the tank. A recreational vehicle with a demand pressure pump system will have low-point drains attached to the water lines (normally located near the water tank).

These low-point drains will release water in the supply lines by opening the valves and all faucets. The water heater has its own drain plug. To drain the permanent fresh water holding tank and supply lines:

1. Turn the water heater power OFF (turn off the electric and LP GAS switches).
2. Open all faucets, including the outside shower faucet (if so equipped).
3. Open the "fresh tank drain" valve. All fresh water tanks can be drained by one of two types of drain valves. A white plastic drain is attached to the exterior wall or a valve located inside the RV adjacent to the water tank (turn 45° to open or close).

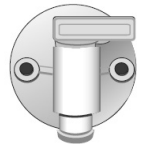

Exterior Fresh Water Drain

SECTION 8: PLUMBING SYSTEM

4. Open the “low point drains” by turning, then pulling the handles up. They are installed at the lowest point of the water lines. A label is placed on the outside of the RV to indicate where the drains are located. The drains will need to be operated from inside the RV. Once the label is found on the exterior sidewall, the drains will be found at a corresponding location in the interior.
5. Drain the sink by removing the drain cap.
6. Turn ON the water pump and allow it to run as needed.
7. If the RV water heater has bypass valves: Set them to the BYPASS configuration (refer to the *Water Heater Bypass* section).
8. Operate the toilet flush lever until water stops flowing.
9. Relieve the water pressure using the P&T valve BEFORE removing the water heater drain plug. If there is any water pressure present, the water will spray out of the opening when the drain plug is removed.

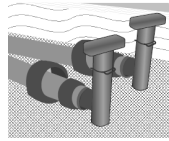

Low Point Drains

When you are finished draining the fresh water system, reverse these steps and dump the grey and black water holding tanks. It is normal for some liquid to remain in the fresh water tank after drainage procedure.

UTILITY CENTER

Water valve settings indicated on the utility center label:

- City Fixtures** - Allows you to access water from all faucets using a pressurized water source (referred to from here on as “city water”).
- City Fill Tank** - Allows you to fill your fresh water tank using city water.
- Country Fill** - Allows you to siphon fill your fresh water tank (using the 12-volt water pump) when you do not have access to city water.
- Normal** - If the RV is not connected to city water, allows you to pump water from the fresh water tank to all faucets using the 12-volt water pump.
- Sanitize/Winterize Lines** – Allows you to sanitize or winterize the water lines.
- Sanitize Tank** – Allows you to sanitize the fresh water tank.



Fig. A -Water Valve Controls

Depending on your model, the city water connections may be configured one of three ways:

1. **A water valve control panel (Fig A).** The City water connection inlet will be located on the outside of the motorhome, and the pump switch inside on the monitor panel.
2. **A horizontal utility center (Fig B).** This utility center contains the city water connection inlet, pump switch, water valve controls, outside shower, black tank flush inlet and a macerator discharge system.
3. **A vertical utility center (Fig C).** This utility center contains an outside shower, city water connection inlet, black tank flush inlet, pump switch and water valve controls.

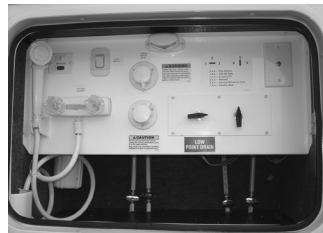
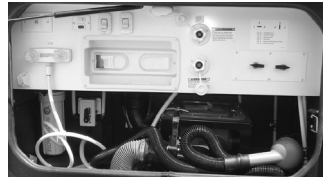

Fig. B - Utility Center

You should always use a non-toxic drinking water hose dedicated only to supplying the motorhome with fresh water through the city water connection inlet. To reduce the chance of contamination, prevent the non-toxic drinking water hose from coming into contact with the ground. Install the city water connection inlet cap when the city water connection is not being used.

NOTE: A short hose is supplied with your motorhome for use in sanitizing or winterizing the water lines in your RV. It can also be used to siphon fill the fresh water tank when no city water is available. One end of this hose has a fitting that will screw onto the city water connection inlet allowing the other end to be put into a container of fresh water, sanitizer or RV antifreeze (refer to *Sanitizing and Winterizing*).



Fig. C - Utility Center

NOTE: The City Water Connection should be unplugged (i.e., the non-toxic drinking water hose disconnected) when the motorhome is unattended for any amount of time. If something would happen to the water system, this may help limit water damage to a smaller area.

Do not remove this label from your motorhome:

Potable Water Only Label
(label appearance may
not be exact)

⚠ WARNING

POTABLE WATER ONLY. SANITIZE,
FLUSH AND DRAIN BEFORE USING.
SEE INSTRUCTION MANUAL.
FAILURE TO COMPLY COULD
RESULT IN DEATH OR SERIOUS
INJURY.

AD-04

Water Control Valve Operation

City Fixtures: Use this setting if the motorhome can be hooked up to an external pressurized water source (referred to as “city water”). **If needed, sanitize the water system prior to travel.**

1. Move the water heater bypass valves (if equipped) to the NORMAL position (supply line valves ON, middle mixer valve OFF). The tankless water heater has no bypass.
2. Remove the city water connection inlet cap and attach a non-toxic drinking water hose to the city water connection inlet and the other end to a pressurized water source.
3. Place the utility center valves in the “CITY FIXTURES” position. (Fig A).
4. Turn ON the water at the external water source.
5. Enter the motorhome and open the cold water supply faucets to bleed air from the water lines. When the water lines are nearly full, you may experience some “air pockets”. Allow these to escape before closing the cold water supply faucets.

SECTION 8: PLUMBING SYSTEM

6. The tank (storage) water heater (if so equipped) will fill first, followed by the supply lines and faucets.
7. Turn the (12-volt GAS or 120-volt ELECTRIC) storage water heater power switch ON. For a tankless water heater, turn the water heater power switch ON (located outside at the water heater panel). The water will be heated on demand.

To disconnect

8. Shut OFF the water at the external water source and disconnect the hose.
9. Disconnect the non-toxic drinking water hose from the city water connection inlet and reinstall the city water connection inlet cap.

City Fill Tank: Use this setting to fill the water tank from a pressurized water source. **If needed, sanitize the water system prior to travel.**

1. If equipped with a tank (storage) water heater, set the bypass valves to the NORMAL position (supply line valves ON, middle mixer valve OFF). The tankless water heater has no bypass valves.
2. Remove the city water connection inlet cap. Attach a non-toxic water hose to the city water connection and the other end to a pressurized water source.
3. Place the utility center valves in the “CITY FILL TANK” position (**Fig A**).
4. Turn ON the water at the external source. Water will flow into the fresh water tank.

During the filling process, periodically check the fresh water tank level using the monitor panel located in the command center. When the fresh water tank is full, it is normal to see water running from the fresh water overflow tubes onto the ground.

To disconnect

5. Shut OFF the water at the external water source.
6. Disconnect the non-toxic drinking water hose and reinstall the city water connection inlet cap.

Country Fill: This setting is used to siphon fill the water tank from a water container when dry camping and a pressurized water source is unavailable. **If needed, sanitize the water system prior to travel.**

1. If equipped with a tank (storage) water heater, set the bypass valves to the NORMAL position (supply line valves ON, middle mixer valve OFF). The tankless water heater has no bypass valves.
2. Remove the city water connection inlet cap and attach one end of the short hose supplied with the motorhome to the city water connection inlet, and the other end into a container of fresh water.
3. Place the utility center valves in the “COUNTRY FILL” position (**Fig A**).
4. Turn water pump ON. Water should begin to be drawn out of the container and into the fresh water tank. To aid siphoning place the container on a flat surface approximately 2 feet off the ground. All low point drains must be off in order to create a siphon.

During the filling process, periodically check the fresh water tank level using the monitor panel located in the command center. When the fresh water tank is full, it is normal to see water running from the fresh water overflow tubes onto the ground.

To disconnect

5. Shut OFF the water pump.
6. Disconnect the short water hose and reinstall the city water connection inlet cap.

Normal Setting: Allows you to use the water system when dry camping. The water pump circulates water from the fresh water tank to all the fixtures. **If needed, sanitize the water system prior to travel.**

1. If equipped with a tank (storage) water heater, set the bypass valves to the NORMAL position (supply line valves ON, middle mixer valve OFF). The tankless water heater has no bypass valves.
2. Place the utility center valves in the “NORMAL” position (**Fig A**).
3. Turn the water pump ON (make sure you have sufficient 12-volt power).
4. Water will be pumped from the fresh water tank to all faucets.
5. The tank (storage) water heater will fill first, followed by the supply lines and faucets.
6. Enter the motorhome and open the cold water supply faucets to bleed air from the water lines. When the water lines are nearly full, you may experience some “air pockets”. Allow these to escape before closing the cold water supply faucets.
7. Turn the appropriate (12-volt GAS or 120-volt ELECTRIC) storage water heater power switch ON. For a tankless water heater (if so equipped) turn the water heater power switch ON (switch is located outside the RV at the water heater panel).. Water will be heated on demand.

Sanitize Tank: This setting is used to sanitize the fresh water tank. When the fresh water tank drain and the low point drains are closed, a siphon is created in the water lines allowing sanitizer to be pulled into the fresh water tank from an external container (see *Sanitization* section).

Sanitize / Winterize Lines: This setting is typically used for drawing RV antifreeze into the water lines of the motorhome. When the fresh water tank drain and the low point drains are closed, a siphon is created in the water lines allowing antifreeze to be pulled into the water lines. This setting will **not** allow antifreeze into the fresh water tank (see *Winterization* section).

Water Heater Bypass – 3 Valves/No Utility Center (if so equipped)

Most models have a factory installed water heater bypass that enables you to avoid filling the water heater with RV antifreeze. The 3-Valve Bypass is typically located in close proximity to the water heater.



NOTE: In the 3-valve bypass diagram, valve D is the fresh water tank shutoff. Valve E is used to introduce RV antifreeze into the lines when winterizing the system and has a clear hose attached to it. See **Winterizing the Plumbing System**. Valves D & E are typically located near the water pump, which may be under a dinette bench, kitchen island, or bed.

SECTION 8: PLUMBING SYSTEM

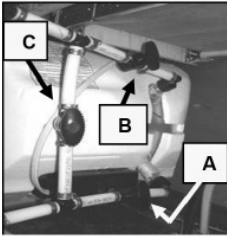

Factory installed 3-valve water heater bypass

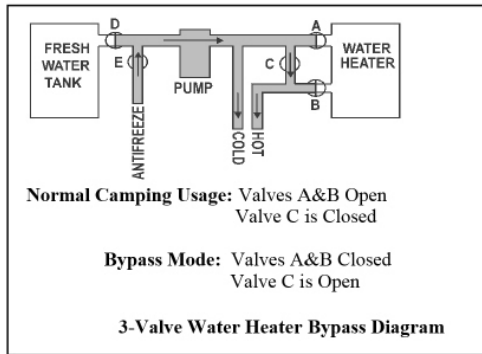

Water Heater Switches (if so equipped)

The water heater switches are typically located on the monitor panel. Refer to the *Monitor Panel* section for function details.

Sanitizing the Plumbing System

When to sanitize

- When your motorhome is new.
- At the beginning and end of each season.
- When the water system becomes contaminated or every three months of use.

Your motorhome may be equipped with a utility center. The sanitizing process is different for units with a utility center than it is for units without one. The following sections will address both applications.

Preparing to sanitize with and without a utility center

- Turn water heater power OFF (storage style-both electric and LP gas switches; tank less water heater turn power switch OFF).
- Level the RV and drain the fresh water system (see *Draining the Fresh Water System*).
- Close the low point drain valves and the fresh water tank drain valve.
- Remove the water filter from the full system canister in the basement area of the motorhome (see *Water Purification* section). Re-attach the empty canister and turn the water supply valves at the filter ON.
- Prepare a chlorine solution using 1/4 cup of household bleach (sodium hypochlorite solution) to one gallon (3.785 liters) of water in a container. Prepare one gallon of solution for every 15 gallons of tank capacity. This will result in a residual chlorine concentration of 50 ppm in the water system.

If a 100 ppm concentration is required, use 1/2 cup of household bleach with one gallon of water to prepare the chlorine solution. One gallon of the solution should be used for each 15 gallons of tank capacity.

NOTE: Fresh water tank sizes vary by model; contact your dealer or customer service for your specific tank size.



NOTE: For complete sanitizing of the fresh water tank, the unit should be driven around for a brief time allowing the solution to splash the sides and top of the tank.

How to sanitize (with utility center)

1. Bypass the (storage) tank water heater: hot and cold supply valves OFF, middle (mixer) valve ON. **Sanitizer should be kept out of the water heater.** The tankless water heater does not have bypass valves.
2. Attach the short hose supplied with your recreation vehicle to the fresh water connection inlet (on the utility center or on the outside of the motorhome). Place the other end of the hose in a container holding the sanitized solution. To assist the syphoning process set the container on a flat surface approximately (2) feet above ground level.
3. Place the utility center valves in the SANITIZE TANK position.
4. Turn the water pump ON.
5. Solution will be drawn into the fresh water tank. When all the solution is in the tank, set the utility center water valves to the city fill tank position.
6. Remove the container and the short hose from the fresh water connection inlet.
7. Attach a hose (can be your drinking water hose) to the fresh water connection inlet and attach the other end of the hose to a potable pressurized water source.
8. Turn on the pressurized water source and finish filling the fresh water tank.
9. When the tank is full, turn off the water source, disconnect the hose from the water source, and remove it from the fresh water connection inlet (at the utility center or on the outside of the motorhome).
10. Set the utility center valves to the NORMAL position.
11. Turn the water pump ON.
12. Open all hot water faucets one by one until water begins to flow continuously and a chlorine smell is noticeable. Include outside shower faucets (if so equipped).
13. Close the hot water faucets and repeat opening all cold water faucets one by one until you smell chlorine. Include outside shower faucets (if so equipped) and toilet.
14. Let the solution remain in the system for at least four hours when disinfecting with 50 PPM residual chlorine. If a shorter time period is desired, then a 100 PPM chlorine concentration should be permitted to sit in the system for at least one hour.
15. After the required period, drain the chlorine solution from the fresh water system (see *Draining the Fresh Water System*). Since the water heater was bypassed there should be no sanitizer in the (storage) tank water heater.

Rinse the system with fresh water

16. Re-fill the fresh water tank using clean (potable) water. Refer to *Country Fill or City Fill in Utility Center* section to re-fill the tank. If city water is not available, the tank can be siphon (country) filled.
17. Set the (storage) tank water heater bypass valves to normal: hot and cold supply lines ON, middle (mixer) valve OFF.
18. Set utility center water valves to the NORMAL position and turn the pump ON to circulate fresh water through the lines.
19. Open hot and cold lines to all faucets and outside shower until chlorine smell is gone.

SECTION 8: PLUMBING SYSTEM

20. Restore power to the (storage) tank water heater only when it is full of water. Tank less water heater: turn the power switch ON (water is heated on demand).



NOTE: If a chlorine taste still lingers in the water, flush the water system with a solution consisting of one-quart vinegar to five gallons of clean water. Re-flush as necessary. The vinegar solution may damage the water heater or the water filter, so both must be bypassed again before performing this operation. To add the vinegar solution, follow the same procedure used to add the sanitizer to the system.

How to sanitize (no utility center)

1. Set the water heater bypass valves to BYPASS: valves A&B closed and valve C open (refer to *Water Heater Bypass Valves* section).
2. Put the sanitizer solution in the fresh water tank: Insert one end of a hose (or funnel) in the gravity fill inlet, insert the other end into a container holding the chlorine solution. Do not use your non-toxic drinking water hose. Pour the chlorine solution into the gravity fill.
3. Remove the hose (or funnel) and container used to pour the chlorine solution, and continue filling the fresh water tank with clean (potable) water until tank is full. Pour fresh water into the gravity fill inlet until tank is completely full.
After the recommended amount of sanitizing solution is in the tank, the water tank is full, and water filter has been removed, turn the pump ON which sends sanitizer into the water lines.



NOTE: The full system canister must have the filter removed

4. Open all hot water faucets one by one until water begins to flow continuously and a chlorine smell is noticeable. Include outside shower faucets (if so equipped).
5. Close the hot water faucets and repeat opening all cold water faucets one by one until you smell chlorine. Include outside shower faucets (if so equipped) and toilet.
6. Turn OFF the water pump.
7. Let the solution remain in the tank & lines for at least four hours when disinfecting with 50-PPM residual chlorine. If a shorter time period is desired, then a 100-PPM chlorine concentration should be permitted to sit in the system for at least one hour.
8. After the required period, drain the chlorine solution from the fresh water system (see *Draining the Fresh Water System*). Since the water heater was bypassed there should be no sanitizer in the (storage) tank water heater.

Rinse the system with fresh water

9. Fill the fresh water tank full of clean (potable) water. Fill fresh water tank from an external container. Pour fresh water into the inlet using a hose (or funnel).

10. Power to water heater should be OFF (both switches: electric & LP gas). When the fresh water tank is full, turn the pump ON to send water through the lines.
11. Run water through all faucets (hot & cold, including outside shower) until chlorine smell is gone. Turn faucets and outside shower off, turn pump OFF.
12. Then, drain the fresh water system again (see *Draining the Fresh Water System*).
13. **Set water heater bypass valves to NORMAL (if so equipped)** close bypass valve C, open valves A and B on water heater, replace water heater drain plug.
14. Refill the fresh water tank with fresh water again and when water heater is full of water, turn the water heater power ON. Refer back to Step 16 above for instructions on refilling the fresh water tank.



NOTE: If a chlorine taste lingers in the water, flush the water system with a solution consisting of one-quart vinegar to five gallons of clean water. Re-flush as necessary. The vinegar solution may damage the water heater or the water filter, so both must be bypassed again before performing this operation.

Follow the steps outlined in *Draining the Fresh Water System* with one exception; do not drain the water heater. **Water heater bypass valves (if so equipped) should be set to NORMAL;** close valves A&B and open valve C. Do not remove the water heater drain plug. For the **full system canister** water filter, remove the canister, take out the filter, and reattach the empty canister.

After draining the system

1. Water heater power should be OFF (both switches: electric and LP gas). Water heater bypass valves (if applicable): A&B should be closed, valve C open.
2. Put the vinegar solution into the fresh water tank. Pour the vinegar solution into the gravity fill using a hose (or funnel).
3. Continue filling the fresh water tank with of clean (potable) water. Pour fresh water into the gravity fill inlet using a hose (or funnel).
4. Run water through all faucets (hot and cold, including outside shower) until chlorine smell is gone. Turn the pump ON to send water through the lines.
5. Close all faucets including outside shower. Turn pump OFF.
6. Drain the system again, but don't drain the water heater. **Water heater bypass valves (if so equipped):** leave valves A&B closed and valve C open. Do not remove water heater drain plug.
7. Close low point drains and fresh water tank drain.
8. Refill the fresh water tank with clean potable water. Use the gravity fill, pour water directly into the gravity fill inlet on the outside of the trailer.
9. Open faucets and check that the chlorine taste is gone.
10. Drain the system one more time (see *Draining the Fresh Water System*).
11. Remove full system canister, insert the filter, and reattach canister to the mount. For **water heater bypass valves (if so equipped):** Open valves A&B, close valve C.
12. Refill the fresh water system with clean water. When the water heater is full of water, turn the water heater power ON.

SECTION 8: PLUMBING SYSTEM

Winterization

WARNING

- ❑ Automotive antifreeze (ethylene glycol) and windshield washer antifreeze (methanol) are poisonous. Never use these products in your fresh water system. These products are harmful and may be fatal if swallowed.
- ❑ Never apply air pressure to the water system with any of the valves in the closed position. Air pressure applied to a closed valve, faucet or low point drain could potentially damage the seals and cause water leaks. If you have questions, consult with your RV dealer. Using RV antifreeze is the preferred method of winterization.

Preparing your motorhome for colder weather or storage is very important for most states and Canada. Failure to prepare your motorhome may cause water supply lines and the water heater to freeze.

The motorhome should be winterized at the end of the camping season or when the motorhome will be exposed to temperatures that will fall at or below 32°F (0°C). Repairs due to freezing are not covered by warranty.

No commodity or product should be added to the fresh water system to ensure freeze protection other than RV antifreeze.

The preferred method is to winterize the plumbing system with RV antifreeze. Please read, understand and follow all instructions before beginning to winterize your motorhome.



NOTE: Appliances (refrigerator, dishwasher or clothes washer) must be winterized. Refer to the appliance owner's manual for possible additional information or contact your Dealer or Customer Service for assistance.

Your motorhome may be equipped with a utility center. The winterizing process is different for units with a utility center than it is for units without one.

The following sections will address both applications. It may be easier to winterize the motorhome with another person to assist you.

Winterizing with Antifreeze Method (with Utility Center)

1. Level the motorhome and drain the fresh water plumbing system.
2. Turn the water valves OFF on each side of the water filter canister. The canister is located behind the utility center. Unscrew the canister and remove the filter. Re-attach the empty canister and turn the water valves ON (refer to the *Water Purification* section).
3. Water heater power switches (12V gas & 120V electric at the command center) should be turned OFF. Gas valve at the water heater should be turned OFF. The tankless water power switch is located outside the RV.
4. Turn the water heater bypass valves (if so equipped) to the BYPASS position. Tankless water heater will not have bypass valves.
5. Move the valves to the "Sanitize/Winterize Lines" position. The low point drains must be closed for the antifreeze to siphon through the lines.

6. Attach the short hose supplied with the motorhome to the fresh water connection inlet and insert the other end of the hose into a gallon container of RV antifreeze (1 gallon should be enough to winterize the motorhome). To assist the siphoning process, put the container on a surface approximately two feet above ground level.
7. Turn the water pump ON. If the water pump fails to self-prime, temporarily open the low point drains. Close the low point drains as soon as the water pump primes (RV antifreeze will begin draining out) and before continuing to the next step.
8. Open the hot water line on all the faucets (kitchen, lavatory, shower and outside shower) until RV antifreeze begins to flow continuously.
9. Appliances should also be winterized.
10. Close the faucet hot water lines and repeat with the cold water lines on all the faucets. Flush the toilet a couple of times until you see antifreeze in the bowl.

CAUTION

Water can accumulate in the flexible hose and dump connector of the macerator system. Antifreeze must be added to the macerator system to prevent freeze damage.

Winterize the Macerator System (if so equipped)

If your motorhome comes equipped with a macerator system, it can retain water in the flexible hose, the dump connector attached to the flex hose, and the macerator box and pipe.

Pour antifreeze into the dump connector and into the 1-1/2-inch flexible hose. Then raise the hose allowing the antifreeze to run back down to the macerator pump. Return the flex hose and dump connector to the storage box.

When you are finished adding RV antifreeze

1. Remove the short hose from the container of RV antifreeze.
2. To prevent staining, wipe the RV antifreeze out of the sinks, shower (or tub) and toilet using a soft, dry cloth.

If needed, contact your RV dealer for assistance.

Winterizing with Antifreeze Method (no Utility Center)



NOTE: Antifreeze should **never** enter the water heater, RV water filter, refrigerator, refrigerator water filter, or fresh water tank.

1. Turn water heater power OFF. Turn water heater gas valve (if so equipped) OFF (outside of the RV).
2. Bypass the water heater. Open valves A and B on the water heater, valve C should be closed (refer to water heater bypass diagram).
3. Level the RV and drain the fresh water plumbing system. (See *Draining the Fresh Water System*).
4. Water heater should be empty after performing Step 2. Water heater bypass valves (if so equipped): A and B should still be closed, valve C open.
5. Make sure the “fresh water tank drain” and “low point drains” are closed.

SECTION 8: PLUMBING SYSTEM

6. Close the fresh water tank shutoff valve “D” (if so equipped). Valve should be located in the vicinity of the water pump.
7. Open valve “E” on the water pump with the clear hose attached and insert the opposite end of the clear hose into a container of RV antifreeze solution. Valve should be located in the vicinity of the water pump.
8. Turn the water pump ON. Antifreeze will be drawn into the water lines.
9. Open the hot water faucets, including outside shower (if so equipped) until RV antifreeze begins to flow continuously.
10. Close the hot water line faucets and outside shower and repeat with the cold water line faucets. Hold open the lever on the toilet until antifreeze runs into the bowl.

When you are finished adding RV antifreeze

1. Turn the water pump OFF. Turn valve E OFF. Remove the clear hose from the container of RV antifreeze. Leave the water tank shutoff valve D closed to keep antifreeze out of the fresh water tank.
2. Pour 1 cup of RV antifreeze into the sink drain P-trap.
3. To prevent staining, wipe the RV antifreeze out of the sinks, shower (or tub) and toilet using a soft, dry cloth.



NOTE: In the spring when flushing antifreeze out of the water lines make sure to turn valve D (the fresh water tank shutoff) back ON.

If needed, contact your RV dealer for assistance.

WATER HEATER

The water heater manufacturer has preset the sensing limit to maintain the water temperature when the water heater is activated.

⚠ WARNING

- ❑ Hydrogen gas may result if you have not used the water heater for two weeks or more. **HYDROGEN GAS IS EXTREMELY FLAMMABLE.** To reduce the risk of injury under these conditions, open the hot water faucet for several minutes at the kitchen sink before you use any electrical appliance connected to the hot water system. If hydrogen is present, you may hear what sounds like air escaping through the pipe as the water begins to flow. Hydrogen gas may be present even after water has been drained from the water heater tank. Open the faucet at the sink and allow the system to vent for five to ten minutes. Do not smoke or have any open flame near the open faucet while venting. On DSI water heater models, make sure the switch is OFF.
- ❑ Do not alter the operation or change the design/construction of your water heater. For your safety, only factory authorized parts should be used on your water heater. Accessories marketed for recreation vehicles, such as an “add-on” electric heating elements, are not recommended by the manufacturer. Such items are not approved to be installed and could create an unsafe condition and will void all warranties
- ❑ **If you smell propane gas then STOP!** and follow the procedures listed in the *Propane System* section before attempting to operate the water heater.

Operating Instructions

Read the safety and operating information provided in the manufacturer’s manual before attempting to activate the water heater.

Make sure the water heater is filled with water before use as even momentary operation of the water heater without water in it may result in damage to the tank heating element and/or controls. **Double check the bypass valves**, make sure they are set properly.

Always open both the hot and cold water faucets when filling the fresh water tank to allow air pockets to be forced out of the water heater.

Water heater switch (if so equipped)

The “propane GAS” switch enables propane operation of the water heater, and the “ELECTRIC” switch enables electric operation. Switches are typically located on the monitor panel. For detailed information, refer to the *Monitor Panel* section.

Water heater-pilot light (if so equipped)

This water heater is gas only with a pilot ignition. The water heater controls are typically located in an outside compartment, and is ignited manually from the outside of the vehicle. Hot water will be available in approximately 30 minutes.

Refer to the water heater manufacturer’s manual for detailed lighting instructions.

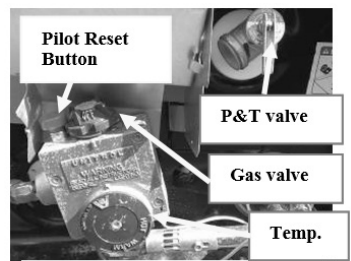

Water Heater pilot ignition

SECTION 8: PLUMBING SYSTEM

Odor from the hot water system

Many water supplies contain sufficient amounts of sulfur to produce an odor, often called “sulfur water”. Sulfur water can be caused by a chemical action or by bacteria. Generally, sulfur water is not harmful, only unpleasant to smell. Refer to the water heater manufacturer’s owner’s manual for details on eliminating the odor from sulfur water. Odor from sulfur water is not a service problem.

⚠ WARNING

Do not replace anode rod or any other component with an accessory part that is not authorized by the water heater manufacturer, such as an “add-on electric heating element. Such items are not approved to be installed and could create an unsafe condition and will void all warranties

NOTE: Depending on your water heater manufacturer, your water heater may or may not have a replaceable anode rod. Check your water heater manufacturer documentation or contact your RV customer service department.

Anode rod protection

The tank in the water heater is protected by a magnesium or aluminum anode to prolong the life of the tank by absorbing the corrosive action of hot water. Under normal use, the anode rod will deteriorate and because of this, the water heater manufacturer recommends the anode rod be replaced yearly. Water with high levels of iron and/or sulfate will increase the rate of deterioration; therefore, more frequent replacements may be required.

If an anode rod is mostly eaten away, replace it with a new one. The water heater manufacturer recommends replacement of the anode rod when consumption or weight loss is greater than 75 percent.

Operating the water heater without the proper anode rod protection will decrease tank life and will void the tank manufacturer’s warranty on the tank. To extend the anode life, drain the water from the water heater tank whenever the RV is not being used. Avoid any extended time of non-use with water in the tank.

To prevent a water leak when replacing the anode rod, a pipe thread sealant approved for potable water (such as Teflon Tape) must be applied to the threads of the anode rod. Proper application of a thread sealant will not interfere with the anode.

High Altitude Deration

Operation of the water heater at high altitudes may require derating. If the water heater is not properly derated, lack of sufficient oxygen for combustion may produce improper burner operation. Pilot outage caused by burner lift-off or sooting from a yellow burner may occur, indicating the possibility of carbon monoxide. You may also notice a lack of efficiency in heating the water because of incomplete combustion of the burner at these higher altitudes. Consult with the local propane company, your dealer or the water heater manufac-

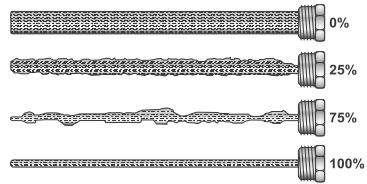

Anode Rod Replacement Chart

turer for proper derating of the water heater. Change out of the orifice (derating) should be done by the dealer or a qualified service agency.



NOTE: It is important that once the RV has returned to lower elevation (below 4500 feet) any high altitude derating or other adjustments be reversed for proper operation of the water heater.

Pressure and Temperature Relief Valve

The temperature and pressure relief valve is designed to open if the temperature of the water within the heater reaches 120° F, or if the water pressure in the heater reaches 150 pounds. When this pressure is reached, the pressure relief valve will open and water will drip from the valve.

This “weeping” or dripping will continue until the pressure is reduced to below 150 pounds, and the valve closes. This condition is normal and does not indicate a defective relief valve.

One way to reduce the frequency of this occurrence is to maintain an air pocket at the top of the water heater tank. This air pocket will form in the tank by design; however, it will be reduced over time by the everyday use of your water heater. To replenish this air pocket:

1. Turn off the water heater.
2. Turn off the cold water supply line.
3. Open a faucet in the recreation vehicle.
4. Pull out the handle of the pressure relief (P&T) valve and allow water to flow from the valve until it stops.
5. Release the handle on the P&T valve - it should snap closed.

Close the faucet and turn on the cold water supply. As the tank fills, the air pocket will develop. Repeat this procedure as often as needed to reduce the frequency of the weeping P&T valve.

⚠ WARNING

Do not place a valve between the pressure and temperature (P&T) valve and the tank. Do not remove or plug the relief valve under any circumstances.

Maintenance

Do not allow the burner to burn with a yellow flame, or continue to operate the water heater with an improper burner flame.

Periodically, inspect the water heater vent for soot. Soot is a sign of incomplete combustion and must be corrected before operating the water heater. This is your visual warning that the water heater is operating in an unsafe manner. If soot is present, immediately shut the unit down and contact your dealer or a qualified service agency.

Periodically inspect the vent for obstructions. Do not terminate the vent on your water heater inside of add-on rooms, screen porches or patios. Doing so will result in products of combustion being vented into the rooms or occupied areas.

SECTION 8: PLUMBING SYSTEM

Draining and Winterization

If the recreation vehicle is to be stored over the winter months, the water heater must be drained to prevent damage from freezing. Damage to the water heater caused by freezing is not warrantable. It is recommended the water heater be drained and bypassed during the winterization process, **particularly if introducing RV antifreeze into the plumbing system. Never drain the water heater when it is HOT or UNDER PRESSURE.**

To drain the water heater:

1. Turn off electrical power to the water heater either at the switch from the electrical element or at the breaker.
2. Shut off the propane supply to the water heater.
3. Turn off the pressure pump on the water system.
4. Open both hot and cold water faucets.
5. Remove the anode rod from the tank.

For detailed information, see the *Winterizing The Plumbing System* and *Water Heater Bypass* sections of this manual.

OUTSIDE SHOWER (IF SO EQUIPPED)

A handheld shower assembly with both hot and cold water may be included for use outside of your recreational vehicle.

1. Be sure the water heater is ON and had sufficient time to heat the water.
2. Open the outside shower compartment door.
3. If dry camping, be sure the 12-volt water pump is ON.
4. Remove the handheld shower from its holder.
5. Turn ON the hot and cold faucet knobs, and adjust the water temperature as desired.
6. To activate the handheld shower turn ON the sprayer head attachment (some models).

To turn off the water, always close the hot/cold control (faucet) knobs. The lever on the shower head will not completely stop the flow of water; this is intentional to allow for draining. After the water has been allowed to drain from the shower head, return it to the outside shower compartment. Any remaining water in the shower hose will drip or run out; this is not a leak but performs as intended. If you are dry camping, turn the water pump OFF.

Turning off the water with the shower head lever can also create a condition where the hot and cold water will mix through the outside shower faucet, thereby reducing the temperature of the hot water. It can appear as though the hot water heater is not working properly.



NOTE: The shower head may be removed from the hose so that it will drain faster. If you remove the shower head, be sure to reassemble it prior to storage.



NOTE: When putting the shower assembly back into the storage compartment, make sure the hose is not pinched or the shower head is positioned in a way it can be damaged.

FAUCETS

The bathroom, kitchen and outside shower faucets operate much the same way as the faucets in your home. Make sure there is sufficient water available and the 12-volt water pump is turned ON before operating.



NOTE: There may be air in the water plumbing lines which needs to be bled out before a steady stream of water comes from the faucet.

BATHROOM TUB / SHOWER

Keep the water heater and holding tank capacities in mind when using the fresh water system. The used water will drain through the plumbing pipes into the grey water holding tank.

- Be sure the water heater is ON and had sufficient time to heat the water.
- If dry camping, be sure your 12-volt water pump is ON.

Unlike your home, the recreational vehicle does not contain a water pressure balance valve. If someone is using the shower, it is recommended that the fresh water system **NOT BE USED** until they are finished.

⚠ WARNING

Water temperatures over 125°F (49°C) can cause severe burns instantly therefore, be careful when using hot water. **Always test the water temperature before showering or washing.**

The shower faucet includes a vacuum breaker for the shower. There are two purposes for this breaker:

- To prevent siphoning water through the hose from another fixture.
- To prevent water from being retained in the hose.

The showerhead DOES NOT have a complete shut-off valve (the complete shut-off is at the faucet). The showerhead may drip slightly in the OFF position after use; this is normal and does not indicate a leak or defect.

Maintenance

Refer the manufacturer's user guide or label instructions for detailed cleaning information. The tub/shower walls are made of ABS plastic material. Use a mild detergent soap and warm water to clean. Do not use gritty or abrasive particle soaps or scouring compound to clean ABS plastic. Avoid using "Citrus" or biodegradable cleaners which contain "D-Limonene." They will damage plastic materials. Contact your dealer for repair or replacement.

BLACK/GREY WATER SYSTEM AND TANKS

Water from the sinks and shower flows into the gray water (or waste water) holding tank. Water from the toilet will flow into the sewage (or black water) holding tank (see Black/Grey Water Holding Tanks).

Drain Pipes with P-Trap (if so equipped)

The drain pipes may be equipped with a "P-trap" installed to help prevent odors from escaping into the RV. During travel, water from the P-traps may spill and permit odors into the RV.

SECTION 8: PLUMBING SYSTEM

By adding water and using a RV approved deodorizing agent you will dissolve the contents faster and will keep the drain lines and tanks clean and free flowing. These chemicals are available at an RV supply store or your dealer.

Drain Pipes with Dry Sealing Valve (if so equipped)

Your RV may be equipped with a dry sealing valve that prevents the escape of odors from your waste system and eliminates the need for P-traps. Should the RV drain piping system become clogged and a mechanical cleanout tool is used to open the drain pipe, it is important that the dry valve be removed before passing the cleanout tool through the piping. Passing a mechanical cleanout tool through the waterless valve may cause damage to the internal seal that may potentially allow sewer gases to escape into the RV interior. The waterless trap can be unscrewed from the water lines. A label has been placed near the location of the waste valve that reads as follows:

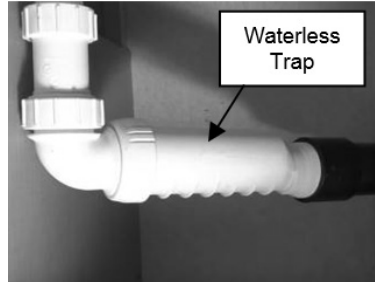

**REMOVE WATERLESS TRAP BEFORE
USING MECHANICAL DRAIN – CLEANING DEVICES**

Sewer Hose Storage

Depending on your RV model, the sewer drain hose may be stored in an exterior compartment marked “Sewer Hose” or it may be located in the hollow square tube bumper. The bumper has removable plastic end caps, and the hose slides inside the hollow bumper.

Vents

Another important part of this system is the vent pipes and vents that release air from the grey and black water holding tanks. On most models the exterior vent cap is attached to the roof and must be kept clear of obstructions to perform as intended.

On some models, the vent pipe may be part of the drainage system referred to as a “wet vent” (water flows downward as air flows upward in the same pipe).

Some models are equipped with a side vent system. On these models this label will be next to the termination valve. This label should not be removed from your recreation vehicle.

▲ CAUTION

Keep drain valve closed to minimize the presence of sewer gases.
Sewer gases may be present when RV is connected to campground sewage hookup.
May lead to illness or personal injury.

Black/Grey Water Holding Tanks

Dump the gray and black water holding tanks before traveling to avoid carrying unnecessary weight. The weight of the holding tank contents is not calculated into the RV cargo carrying capacity (this extra weight would reduce your available cargo capacity). Traveling with full holding tank(s) could possibly cause you to exceed the individual tire ratings and/or the RV GAWR or RV GVWR. Potential damage to suspension components, such as springs, tires and axles, could result.

If you are dry camping and cannot immediately empty your holding tanks, reduce your vehicle speed until you reach a dumping station. When connected to the sewer drain line at a campground, keep the “black tank drain” valve closed until the holding tank is at least $\frac{3}{4}$ full. This will provide sufficient water to assist in complete draining of the black water holding tank. Repeat as needed.

⚠ WARNING

Never travel with full black or grey water holding tanks. This not only wastes your fuel but depending on the location of the tank(s), it can affect your tow vehicle handling characteristics.

⚠ CAUTION

- ❑ Never leave the black tank drain in the open position continuously when connected to the campground sewer system. Leaving the drain open will allow the liquid to drain out increasing the potential for a blockage in the tank. Keeping the drain in the closed position will prevent debris from accumulating in the tank.
- ❑ Do not add automotive antifreeze or caustic chemicals, such as laundry detergents, into the holding tanks. Although these products may have a deodorizing effect, they may damage the plastic and rubber parts of the plumbing system or the components

Before using the recreation vehicle, or after dumping the grey and black water holding tanks, always add the proper amount of deodorant to the black water tank to prevent odors and help break down holding tank contents (unless winterizing). Follow the deodorant bottle or package instructions. Driving to a disposal site will normally loosen any accumulated waste debris or solids from the sides of the holding tanks.

BLACK AND GREY TANK DRAINS

There are labels on the exterior of the recreation vehicle indicating the location of the grey and black tank drains (also called dump valves). Always drain the black water holding tank first so the following grey tank waste water can help rinse any solids or debris from the dump outlet and sewer hose.

1. To make drainage easier, level the RV.
2. Remove the sewer hose housing dust cap, and attach the sewer hose (customer supplied).
3. Place the end of the sewer hose into the approved dump station.
4. Open the black tank dump valve (depending on your model the valve may be located under the RV, or on the utility center). Close the dump valve when the black water holding tank is empty.
5. Open the grey tank dump valve (depending on your model the valve will be located under the RV or on the utility center). Close the dump valve when the grey holding tank is emptied.
6. Remove, clean and store the sewer hose.
7. Close the sewer hose housing dust cap.



Black/Grey Tank Drain and Valves

You can locate many dump stations throughout the United States and Canada in Woodall's, Rand McNally Camp Guide, Good Sam Camp Guide, KOA Kampgrounds Camp Guide and various other publications. Some fuel stations also have dump stations. Please contact your RV dealer for assistance in the purchase and installation of a sewer hose or sewer hose extension (if needed).

SECTION 8: PLUMBING SYSTEM

Sewage (black) tank preparation

WARNING

It is important to add enough water to prevent solid waste buildup. Follow the directions listed below and in the manufacturer's operator manual.

1. Release one to two quarts (1 or 2 liters) of water into the toilet bowl.
2. Follow the directions on your (RV approved) toilet chemical bottle (customer supplied), by placing the recommended quantity of holding tank chemical into the toilet bowl.
3. Flush the toilet and allow at least two gallons (8 liters) of water to flow into the holding tank.

Waste (grey) holding tank preparation

No special preparation is required, however, placing a small quantity of chemicals into this tank, such as baking soda or an approved RV chemical, will reduce odors from food particles in the system.

Cleaning and maintenance

The toilet should be cleaned regularly for maximum sanitation and operational efficiency. Use only RV approved chemicals. Do not use chlorine (undiluted) or caustic chemicals, such as laundry bleach or drain opening types, in the toilet system. These products damage the seals in toilets and dump valves.

BLACK TANK FLUSH (IF SO EQUIPPED)

The black tank flush (no fuss flush) inlet is typically located on the utility center panel. The location may vary depending on your model. The inlet color may be either white or black. Attach a garden hose (connected to a pressurized fresh water source) to the black tank flush inlet. The water goes directly into the black water holding tank sprayer connection, allowing you to remove debris and preventing accumulation. There is a check valve in the plumbing lines to prevent back flow. Flush the black water tank each time the grey and black water holding tanks are dumped or as needed.

1. Dump the black water tank (see Black and Gray Tank Drain) and leave the black tank drain valve open.
2. Connect a garden hose from the water supply source to the black tank flush.
3. With the water source turned ON, flush the black water holding tank until the water running out of the black tank drain valve is clear (not discolored or cloudy).
4. Disconnect the garden hose and close the black tank drain valve. Fasten the sewer hose housing dust cap back on the tank flush inlet.



Tank Flush Inlet

CAUTION

- The black tank drain valve must be OPEN any time there is a hose (water supply) connected to the black tank flush.
- Do not leave any hose (water supply) connected to the black tank flush when it is not in use.

⚠ WARNING

Do not use the same hose to fill your fresh (potable) water tank that is used for the black tank flush.

TANK HEATERS (IF SO EQUIPPED)

Your recreation vehicle may be equipped with heaters for the fresh, gray, black water tanks and the water lines or drain lines. The larger tank heaters are 120VAC and attach directly to the tanks. Water line or drain line heaters are smaller and operate on +12VDC and will be attached to the water lines or drain lines. These heaters will prevent water in the tanks and lines from freezing down to -11°F (-24°C) (contingent on recreation vehicle setup).

The tank heaters are thermostat controlled and will cycle on and off while they are operating. The +12VDC heaters stay on constantly. The thermostat controlled tank heaters turn ON at 44°F (7°C) and will turn OFF at 64°F (18°C). All of the heaters are controlled by a single ON/OFF switch.

Typically, this red tank heater ON/OFF switch is located on the command center panel or in the bathroom. The switch lights up red when it is turned ON and controls the heater circuit.

NOTE

- In order for the 120VAC tank heaters to be in operation, the recreation vehicle **MUST** be hooked up to shore power or under generator power.
- If the recreation vehicle is not operating on shore power or generator power, **only the +12VDC heaters will operate. This can result in the tanks freezing.**
- The red light on the command center tank switch does not necessarily indicate that **ALL** heaters are operating; it is a only a warning that the heater circuit is ON.

The tank heater switch should be turned ON:

- When liquid is present in the holding tanks and the outside temperature approaches and maintains freezing conditions 35°F (2°C) or colder.

The tank heater switch should be turned OFF:

- When there is NO liquid present (tanks are empty).
- When dumping the black and gray holding tanks and the drain pipes.
- When fresh water tank and supply lines are empty or being drained for storage.
- When the recreation vehicle is connected to city sewer and the gate valves are open.



NOTE: Free draining is never recommended, especially in cold weather use..

- When ambient temperatures rise and remain above freezing.

No maintenance on the heaters is required, only a periodic inspection for loose wires, damage, etc. For additional detailed information, refer to the tank heater manufacturer’s user guide.

SECTION 8: PLUMBING SYSTEM

TOILET

The toilet is efficient and easy to operate. Prior to using the sanitation system, it is strongly recommended to flush the toilet several times to release sufficient water into the holding tank. Generally, more water is required only when flushing solids.



CAUTION

- It is important to prevent solid waste buildup. Follow the toilet manufacturer's recommended instructions each time after emptying the black water holding tank.
- To prevent help toilet blockage, always use RV grade single-ply toilet paper. Do not flush paper towels, diapers, sanitary napkins or other foreign objects down the toilet.
- Do not use chlorine (undiluted) or caustic chemicals, such as laundry bleach or drain opening types, in the toilet system. These products damage the seals in toilets and dump valves.

The toilet system will perform better when water is run for ten to fifteen seconds after flushing to ensure that the waste will proceed to the bottom of the tank.

If there is not a sufficient amount of water used during flushing, the waste materials may not evacuate properly from the drain line to the tank. Clogged tanks and pipes could eventually occur. For added convenience and better sanitation system performance, it is advisable to always have four to six inches (10 - 15 cm) of water in the toilet. It is important to add enough water to prevent solid waste buildup. The following guidelines will help to prevent solid waste buildup.

Sewage (black) tank preparation

1. Release one to two quarts (1 or 2 liters) of water into the toilet bowl.
2. Follow the directions on your (approved RV) toilet chemical bottle (customer supplied), by placing the recommended quantity of holding tank chemical into the toilet bowl.
3. Flush the toilet and allow at least two gallons (8 liters) of water to flow into the holding tank.

Cleaning and Maintenance

The toilet should be cleaned regularly for maximum sanitation and operational efficiency. For detailed information refer to the manufacturer's operator manual.

AIR CONDITIONER

The air conditioning system is controlled by a thermostat. Cooled air enters the RV through the grill. Make sure you have sufficient power available before operating the air conditioner. Do not operate the air conditioner without the return air filter. Operating the system without the filter allows the lint and dirt that is normally stopped by the filter to accumulate on the cooling coil of the air conditioner. This also will lead to a loss of air volume, possible equipment damage and an expensive cleaning process.

Roof Mount (if so equipped)

A special foam gasket is placed between the roof material and the subframe of the air conditioner to guard against water leakage. The air conditioner is subjected to wind pressures along with motor vibration during normal operation. Inspect the mounting bolts for tightness to ensure there is no leakage or looseness at least annually. Re-tighten bolts when they are loose. DO NOT over tighten these bolts as it may damage this gasket. The air conditioner gasket is a wearable part that eventually will need to be replaced. To gain access to the bolts, remove the filtered panel cover on central air systems or the entire air box on non-central air conditioners.

Wall Mount (if so equipped)

Keep the air inlet grill and cabinet clean by wiping with a cloth dampened with warm water and a mild detergent.

Heat Pump Operation (if so equipped)

Set the thermostat for either electric or gas heat. On the electric setting, the heat pump will become the primary heat source as long as the interior temperature of the RV has not dropped 5° below the thermostat set point. If this occurs, the thermostat will automatically activate your gas furnace.

The furnace will continue as the heat source until the thermostat set point has been satisfied. At that point, the heat pump will again become the primary heat source.

For additional information refer to the manufacturer's owner's manual included in your warranty packet or consult your dealer.

POWER ROOF VENT (IF SO EQUIPPED)

The 12-volt DC attic fan (or powered roof vent) allows fresh air to circulate through the recreational vehicle. Do not leave the attic fan open when the recreational vehicle is stored or unattended for long periods.

High winds, other unusual conditions or obstructions may prevent the dome from closing; the resulting leakage could cause non-warrantable damage.

To use your fan most effectively, close all vents and slightly open a window on a shaded side of your recreation vehicle. You are directing the air flow by opening a window.

For additional safety and operating information refer to the manufacturer's owner's manual.

Control pad (if so equipped)

The attic fan may be controlled by a control pad. The dome can be raised or lowered with the UP/DOWN buttons, and the speed of the fan is controlled by the ARROW buttons. It is also equipped with a rain sensor that will close the vent automatically when it rains. The rain sensor can be turned on/off by holding the DOWN button for 3 seconds.

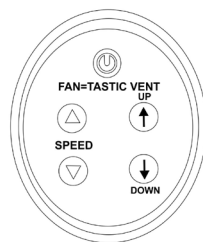

Attic Fan Control

SECTION 9: HEATING & COOLING

FURNACE

The furnace installed in your recreation vehicle is controlled by a 12-volt DC thermostat. Depending on your model, there may be up to two thermostats enabling you to control the temperature to your comfort level.

The furnace requires both 12-volt power and propane gas for full operation. Make sure you have sufficient power available before operating your furnace.

If you have any questions contact your dealer or Customer Service. A qualified RV technician should perform all furnace maintenance at least once a year (more often depending on furnace usage). Never attempt to repair the furnace yourself.

Ducting and Return Air

All heat discharges, registers and return air grills must be free and clear of obstructions. This includes all closeable registers that are intended to reduce airflow, do not shut it off completely.

WARNING

- The furnace should be inspected periodically (monthly during the heating season) for presence of soot on the vent. Soot is formed whenever combustion is incomplete. This is a visual warning that the furnace is operating in an unsafe manner. If soot is observed on the vent, immediately shut the furnace OFF and contact a qualified service agency. Operating the furnace under this condition could lead to serious property damage, personal injury or loss of life.
- To ensure your personal safety, do not obstruct or alter the furnace in any manner. Do not install screens over the vent for any reason. Screens will become restricted and cause unsafe furnace operation. For your safety, only the manufacturer's factory authorized parts should be used on your furnace.

FIREPLACE (IF SO EQUIPPED)

Your recreational vehicle may include an electric fireplace insert. For detailed operating and safety information, refer to the manufacturer's user guide.

MICROWAVE

 CAUTION
<ul style="list-style-type: none"><input type="checkbox"/> To prevent damage, remove the turntable from the microwave when traveling.<input type="checkbox"/> Make sure you are connected to a 120-volt power source.

 WARNING
Never use the microwave cavity for storage. The microwave cavity should always be empty when not in use.

For details on operation, cleaning and safety information, refer to the manufacturer’s user guide.

General Cleaning Microwave and Convection Microwave

IMPORTANT: Before cleaning, make sure all controls are off and the microwave oven is cool. Always follow label instructions on cleaning products.

To avoid damage to the microwave oven caused by arcing due to soil buildup keep cavity, microwave inlet cover, cooking rack supports, and area where the door touches the frame clean.

Clean with mild soap, water and a soft cloth or sponge, or as indicated below.

- Grease filters: mild soap and water or dishwasher.
- Door and exterior: mild soap and water, or glass cleaner applied to paper towel.
- Control panel: sponge or soft cloth and water.
- Stainless steel (on some models): mild soap and water, then rinse with clean water and dry with soft cloth, or use stainless steel cleaner.
- Turntable: mild soap and water or dishwasher.
- Rack(s): mild soap, water and washcloth. Dishwasher cleaning is not recommended.

Convection Microwave (if so equipped)

The convection microwave bridges the gap between microwaving your food and conventional cooking. Make sure there is sufficient 120-volt power before operating the convection microwave (see *Calculating Electrical Load*). For details on operation and safety information, refer to the manufacturer’s user guide.

COOKING SAFETY

In Case Of a Grease Fire

 WARNING
Do not attempt to use water to put out the fire. Water can spread some types of fire, and electrocution is possible with an electrical fire.

Grease is flammable. Never allow grease to collect around top burners or on the cook top surface. Wipe up spills immediately. Refer to Section 2 – Safety Precautions, for fire safety and fire extinguisher information.

SECTION 10: APPLIANCES

Cooking With Propane (if so equipped)

See the *Propane System Section* for important safety instructions. Refer to the manufacturer's owner's manual for detailed operating and safety instructions for all propane appliances.

COOKTOPS; RANGE AND OVEN (IF SO EQUIPPED)

For detailed operating and safety information, refer to the manufacturer's user guide.

WARNING

- During and after use, do not touch or let clothing or other flammable material come in contact with the top burners (or heating elements), burner grates or other areas near the top burners or oven until they have had sufficient time to cool. These areas can get hot enough to cause burns.
- Never leave cooking food unattended. Turn pan handles inward, but not over the tops of the other range burners. Ensure that pans used are large enough to contain the food and avoid boil-overs. Heavy splattering or spills left on the cooktop can ignite and cause burns.
- If using glass, glass/ceramic, ceramic, earthenware or other glazed utensils (or cookware) verify it is safe for use on the top burners. Only certain types of utensils (or cookware) are suitable for surface or top burner use.
- Do not cover the oven vent openings while the oven is in operation.** Restricting the flow of combustion air will create an asphyxiation hazard.

CAUTION

Never use oven cleaners, chlorine bleach, ammonia or glass cleaners with ammonia. Always allow the cooktop to cool before cleaning.

Cleaning instructions

Refer to the manufacturer's user guide included for detailed cleaning instructions.

General Cleaning

- To avoid damage and possible burns, be sure the appliance is off and all parts are cool before handling or cleaning.**
- Use care to avoid steam burns if a wet sponge or cloth is used to wipe spills on a hot surface.
- Some cleaners can produce noxious fumes if applied to a hot surface.
- To prevent staining or discoloration, clean appliance after each use.
- If a part is removed, be sure it is correctly replaced.
- If a spillover occurs while cooking, immediately clean the spill from the cooking area while it is hot to prevent a tough cleaning chore later. Using extreme care, wipe spill with a clean, dry towel.

Electric Drop-In Cooktops (if so equipped)



NOTE: Make sure you are connected to a 120-volt power source.

⚠ CAUTION

Do not use aluminum foil on the electric range cooktop, as this material will damage the cooktop surface if it melts. **Do not use aluminum foil under any circumstances on the electric range cooktop.**

Gas Drop-In Cooktops (if so equipped)

Depending on your model, it may be equipped with either a 2 burner or 3 burner cooktop. The 2 burner match-light cooktop has two 6500 BTU/H burners with control panel.

The 3-burner piezo-igniter cooktop has (1) front 9000 BTU/H burner and two rear 5200 BTU/H burners. The 3 burner cooktop is also equipped with a control panel.

Refer to manufacturer’s user guide for detailed operating and cleaning information.

Kitchen Range and Oven (if so equipped)



NOTE: To help reduce potential condensation or unwanted cooking odors, turn on the overhead kitchen roof vent or the range hood vent (if so equipped)

To prevent damage, always use the manufacturer’s recommended size flat bottom pan(s). Generally, the pan should be large enough to cover the burner, but not be more than one inch larger than the burner grate.

Do not use a broiler pan, griddle or any other large utensil that covers more than one burner at a time. This will create excessive heat that may cause melting, sooting or discoloration.

The use of undersized pans could expose a portion of the heating element to direct contact and may result in ignition of clothing. Proper relationship of pans to burner will improve efficiency.

Oven (if so equipped)

The propane gas oven must have 12-volt power to operate. If you have any questions, contact your dealer or our customer service department. **Do not use the oven as a storage area.** Refer to the manufacturer’s user guide for detailed operation, cleaning and safety information.

LP GAS GRILL HOOKUP (IF SO EQUIPPED)

Gas BBQ Grill Prep (if so equipped)

Your recreation vehicle may be equipped with a propane “quick-coupler” connection and support bracket for easy installation of the BBQ grill. Typically this connection is located at the LP tank bracket.

Attaching the “Quick Coupler” Connection

The “quick coupler” is directly connected to the RV propane system. The “quick-coupler” connection is equipped with a positive shut-off valve.

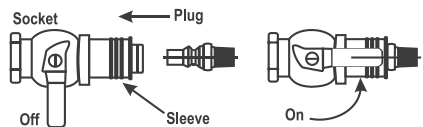

Quick Coupler Connection

Place the “quick coupler handle in the OFF position and push back the sleeve. The valve handle must be OFF to make the connection.

SECTION 10: APPLIANCES

1. Insert the plug and release the sleeve.
2. Push the plug until the sleeve snaps forward, locking the plug into the socket.
3. Turn the handle ON to allow propane to flow to the drop in stove.

⚠ WARNING

- ❑ Be sure to read, understand and follow all information supplied with your recreation vehicle concerning the use of propane before operating the BBQ grill. The propane hose must be correctly connected before lighting the grill. Failure to follow instructions supplied by the grill manufacturer, or use of any components other than those originally supplied with the grill, could result in death or serious injury.
- ❑ **If you smell gas: Shut off gas to the appliance; extinguish any open flame; open lid; if odor continues, immediately call you gas supplier or your fire department.**
- ❑ The BBQ grill is intended for use outside of the recreational vehicle. **Never use a gas grill inside a compartment or inside of the recreational vehicle.**
- ❑ The BBQ grill must be **COMPLETELY COOLED** before storing it. The grill should be cool to the touch before storing. Storing the BBQ grill before it is completely cool may result in serious injury or property damage.

⚠ WARNING

Always open the grill lid before turning on gas and lighting burner, failure to open the lid before lighting could cause an explosion causing property damage, injury, or even death.



NOTE: Outdoor cooking warning label should not be removed from the RV.

⚠ WARNING

When using this outdoor cooking area:

- The vehicle must be level and stabilized.
- Do not violate manufacturers' instructions on required clearances for cooking appliances during use.
- Do not store cooking appliances until cool to the touch.

Can lead to a fire and explosion and result in death or serious injury. AD-126

RANGE HOOD (IF SO EQUIPPED)

If your recreational vehicle is equipped with a range hood, it will be connected to an exterior vent.

The vent has an inner flap with two snaps. This flap can be snapped shut when the vehicle is in motion, or during storage to keep insects, debris, snow, rain, etc. from entering the recreational vehicle.

Anytime the stove inside the recreational vehicle is being used, this flap **MUST** be unsnapped and the range hood turned ON to vent fumes outside the vehicle.

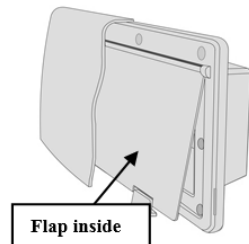

Range Hood Vent

 WARNING

Whenever the stove in the RV is being used: The range hood **MUST** be turned on, and the inner flap **MUST** be unsnapped and free to move. Failure to do so can create an asphyxiation hazard by restricting air flow to this vent.

REFRIGERATOR

The refrigerator is not intended for quick freezing or cooling. We recommend stocking it with pre-frozen or pre-cooled food when possible. The shelves should not be covered with paper or plastic and the food items should be arranged so air can circulate freely. Keep the area at the back of the refrigerator clean and free of debris. Check for obstructions in the exterior refrigerator vent area (i.e., spider webs, bird nests, etc.). Use a soft cloth to dust off the debris.

For optimum efficiency and performance, it is recommended the refrigerator be checked at least twice a year as part of the routine maintenance.

For detailed operating and safety information, refer to the manufacturer's user guide.

Gas/Electric Models (if so equipped)

 WARNING

If you smell propane gas **STOP!** Follow the directions located in your manufacturer's owner's manual and in this manual.

Residential Models (if so equipped)



NOTE: If you are using electric to power the refrigerator, make sure you are connected to a 120-volt power source.

 CAUTION

The ice maker (if so equipped) should be turned off and the ice tray emptied when power to your recreation vehicle has been shut off. With no power, the ice will melt and water may "pool" in the refrigerator door. When power is restored, the vibration may cause this water to run out of the door and on to the vehicle floor.

SECTION 10: APPLIANCES

3-Way Refrigerators (if so equipped)

Depending on your model, you may have a 3-way refrigerator (12VDC, LP GAS or 120VAC).

WARNING

Converter output (12VDC) is not intended for normal operation of the 3-way refrigerator. When the camping trailer is parked and the power cord is plugged in, set the 3-way refrigerator to “AC power.” The “DC mode” is to be used only when traveling and will pull power from the auxiliary battery charge line (if so equipped). When camping without available AC power, utilize the propane mode.

Contact your dealer or Customer Service for details on winterizing your refrigerator.

Cleaning Your Refrigerator

The following are general cleaning guidelines. For detailed information on cleaning your specific refrigerator, refer to the manufacturer’s user’s guide.

Cleaning the Interior

1. Unplug refrigerator or disconnect power.
2. Hand wash, rinse, and dry removable parts and interior surfaces thoroughly. Use a clean sponge or soft cloth and a mild detergent in warm water.
3. Inside the refrigerator, use a warm water and baking soda solution consisting of approximately 1-tablespoon (15ml) baking soda to 1 quart (1 liter) of water. This solution cleans and neutralizes odors. Rinse and wipe dry.
4. Leave an open box of baking soda in the refrigerator and freezer to help prevent odors.



NOTE: Do not use abrasive or harsh cleaners such as window sprays, scouring cleansers, flammable fluids, cleaning waxes, concentrated detergents, bleaches or cleansers containing petroleum products on plastic parts, interior and door liners or gaskets. Do not use paper towels, scouring pads, or other harsh cleaning tools.

There is no need for routine condenser cleaning in normal operating environments. If the environment is particularly greasy or dusty, or if there is significant pet traffic, the condenser should be cleaned every 2 to 3 months to ensure maximum efficiency.

If you need to clean the condenser:

- Remove the base grille.
- Use a vacuum cleaner with a soft brush to clean the grille, the open areas behind the grille and the front surface area of the condenser.
- Replace the base grille when finished.

Cleaning the Exterior

Painted metal exteriors: Wash with a clean sponge or soft cloth and a mild detergent in warm water. **Stainless steel exteriors:** Wash with a clean sponge or soft cloth and a mild detergent in warm water. Do not use appliance wax, polish, bleach, or other products containing chlorine on stainless steel. Stainless steel can be cleaned with a commercially available stainless steel cleaner. A spray-on stainless steel cleaner works best.

IMPORTANT: Do not allow the Stainless Steel Cleaner and Polish to come into contact with any plastic parts such as the trim pieces, dispenser covers or door gaskets. If unintentional contact does occur, clean plastic part with a sponge and mild detergent in warm water. Dry thoroughly with a soft cloth.

For silver-accented plastic parts, wash with soap or other mild detergents. Wipe clean with a sponge or damp cloth. Do not use scouring pads, powdered cleaners, bleach or cleaners containing bleach as these products can scratch and weaken the paint finish.

WATER HEATER – SEE PLUMBING SECTION

SECTION 10: APPLIANCES

Notes:

HDTV ANTENNA/SATELLITE SYSTEM

Your recreation vehicle may be equipped with an exterior amplified high definition TV antenna. The antenna comes equipped with a signal meter and a power injector to aid in receiving the strongest possible signal when tuning in HDTV stations.



King HDTV antenna

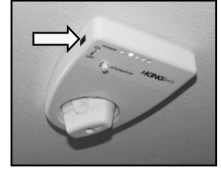

Base & Signal Meter

Antenna Positioning: The knob on the base inside the RV is used to rotate the outdoor roof antenna. The arrow on the knob should be pointed towards the TV signal source (TV station). Press the button on the side of the knob and turn it to rotate the antenna for optimum signal. The antenna will rotate a full 360°.



NOTE: This antenna is a fixed height (12") and cannot be lowered or raised. Trees and foliage will interfere with receiving a strong HDTV signal.

Power Injector (if so equipped): The power injector button located on the wall plate, switches between your cable/satellite signal and the over-the-air (OTA) HDTV signals. When the button on the wall plate is turned ON, it lights green and interrupts the satellite/cable input to the TV. It allows the OTA HDTV signals from the outside roof antenna to your TV. When the button is turned OFF, satellite/cable signals are resumed again on your TV.

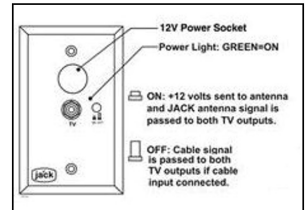

Power Injector

Signal Strength Meter (if so equipped): The base may have a built in signal strength meter to aid in obtaining maximum TV signal. A row of LED lights will light up on the face of the base enclosure to indicate signal strength. Optimum signal is indicated when the maximum number of LEDs are lit.

- Make sure the power injector is turned ON at the wall plate which turns power on to the antenna.
- To turn on the signal meter, slide the black button on the side of the base (arrow in photo).
- Rotate the small attenuator knob on the face of the base enclosure fully clockwise.
- Press the button on the side of the large knob with the arrow, and rotate it until the maximum number of LEDs light.
- Rotate the small attenuator knob counter-clockwise until the last illuminated LED light flickers.
- Rotate the large antenna knob to illuminate the last flickering LED light.
- Refer to your TV (or converter box) manual for information on scanning for available OTA channels.

SECTION 11: ELECTRONICS

Antenna Power Supply (if so equipped)

For good station reception, the antenna power supply must be turned ON to view local television stations. Turning the antenna power supply ON sends 12-volt DC through the cable to the TV roof antenna. The voltage energizes the transistors in the antenna head amplifier. The TV signal then comes down the cable to the outlets.

Turn the antenna power supply OFF to view cable television or to use a VCR or DVD. The ON/OFF switch is located on the wall plate for the antenna connection.

Satellite (if so equipped)

Please refer to the manufacturer's instructions for setup, care and maintenance.



**Antenna Power
Supply**

EXTERIOR ENTERTAINMENT CENTER (IF SO EQUIPPED)

The exterior entertainment center is located on the curbside of the unit. You can access the entertainment center by opening the exterior cargo door to the stationary open position.

Refer to the individual component manufacturer's information for detailed operating instructions.

CLEANING THE INTERIOR

To keep the value of your recreation vehicle, perform regular maintenance using the proper materials and procedures. Using the wrong cleaner may result in damage to the surfaces in your vehicle. Check with the manufacturer's information for the recommended cleaning agent. If in doubt, check to see if the cleaner will cause damage by testing a small area out of sight or contact your dealer for assistance. Do not use flammable liquids or sprays to clean the recreation vehicle.

Décor Glass (if so equipped)

Use a glass cleaner to remove smudges, smears and spots. If there is decorative etching on the décor glass, use care when cleaning around that area.

Furniture Upholstery

To retain the value of your recreation vehicle, maintain the furniture upholstery carefully and keep the interior clean. Vacuum the furniture regularly using a soft brush attachment to remove any loose dirt or debris.

Fabric (if so equipped)

It is recommended the fabric be professionally cleaned if it becomes stained or soiled. The professional cleaner should be made aware the fabrics that may have been treated to be fire resistant. For more information, refer to the specific furniture manufacturer's care instructions.

Ultraleather™ (if so equipped): It is recommended the Ultraleather™ be professionally cleaned if it becomes stained or soiled. For more information, refer to the specific furniture manufacturer's care instructions.

Leather (if so equipped): Periodic vacuuming, using a dry cloth to wipe up spills immediately, and using a damp cloth on problem areas, will help to keep your leather furniture in good condition. Leather surfaces can vary, as do the cleaning methods. Refer to the furniture manufacturer's recommendation, or consult a cleaning professional.

It is recommended you do not use any cleaners containing oils, waxes or silicones. Cleaners containing silicone can eventually destroy the finish on the leather. Cleaners containing oils or waxes should not be used as they leave residues on the surface of the leather which can attract more dirt which can eventually lead to cracking.

Window Treatments

Fabric – Drapes and valances: Dust occasionally with a vacuum and soft brush attachment. It is recommended the fabric be professionally cleaned if it becomes stained or soiled. The professional cleaner should be made aware the fabrics that may have been treated to be fire resistant.

Window Shades

Shades should be vacuumed periodically to remove dust. It doesn't matter what type of shade or fabric you have, using your vacuum cleaners upholstery brush on low suction will remove most dust and dirt from the shade. Refer to the shade manufacturer's owner's manual for additional and detailed information.

To remove stuck on dust or stains refer to the following guide.

Solar shields: Use a sponge or soft brush and water to remove stains. A mild cleaning solution can be used to remove tougher stains. Rinse after cleaning by wetting a clean cloth in fresh water, wringing out any excess and wiping the areas where the cleaner was used.

Day/Night Shades: Clean with a mild cleaning solution using a sponge or paper towel. Wipe down with water after cleaning and dry thoroughly before raising the shade. Do not

SECTION 12: INTERIOR

use spot remover, household cleaners or detergents to remove soiled spots, as these may cause damage to fabric or loss of color from fading.

Mini Blinds: A simple dry rag may do the trick. If they are especially dirty, you can use cold or warm water to clean them; **never use hot water.**

Fill a spray bottle with water and a tiny amount of soap. Then spray a lint-free towel with the mixture and use the towel to wipe down each slat. While cleaning, try not to bend the slats. They can also be soaked in a bathtub to loosen up any debris so the slats can be wiped down easily.

Roller Shades: Can be easily cared for by simply using soapy water or a mild cleaning solution on spots. However, try a small area first. Harsh household cleaners or detergents may cause damage to fabric or loss of color. It is our recommendation to dust the rails and fabrics of the shades on a regular basis. Shades should be kept in the closed or up position when not in use, to maintain pleat retention and minimize dirt and soil build-up. Do not store shades in the down position. This may cause some loss of pleat retention if the shades are not operated on a consistent basis.



NOTE: If your recreation vehicle must be stored for an extended period of time, store shades in the up position and cover your windows with additional protection (I.E. Cut out cardboard).

Cabinetry and Tables

To keep hardwood doors, cabinet fronts and hardwood tables looking like new regularly dust with a soft cloth dampened with a cleaning polish or mild detergent solution. Avoid using ammonia based products or silicone oils as they may cause damage if used over a long period of time.

The finish is durable and resistant to most household spills. However, spills should be wiped up promptly to avoid potential problems. Excessive prolonged exposure to direct sunlight, high temperatures and high humidity can cause damage to both the finish and the wood itself. These should be avoided.

Interior Wall Panel

Please contact your dealership service department for assistance in repairing décor paneling. If deep scratches occur on the wall panel, putty sticks can be used to cover scratches on wood surfaces. These can be obtained from local hardwood stores and lumberyards.

To clean, use a mild solution of soap and lukewarm water with a soft sponge or cloth. Wipe dry with a soft, clean cloth.



CAUTION

Do not use abrasive cleaners as they may cause the vinyl to scratch and become dull. Do not use cleaners that contain bleach

Quik Panel Wall Panels (if so equipped)

Quik Panels are used on certain Entegra motorhome models and may be treated and cleaned as a high quality painted surface. All Quik Panels are sealed or glazed and can be cleaned with a soft cloth and mild soap and water (such as dish soap).

ABS Plastics

Dust and wipe clean with soft, damp cloth or chamois, wiping gently. Do not use gritty or abrasive particle soaps or scouring compound to clean ABS plastic. Avoid using “citrus” or biodegradable cleaners that contain “D-Limonene” as they may damage plastic materials.



NOTE: Oil based soaps and cleaners are not recommended. No abrasive cleaners or alcohol cleansers should be used. If other cleaner solutions are used, we recommend trying a spot in an inconspicuous area.

SOFA AND DINETTE

 WARNING

Always use seatbelts if sitting in the sofa or dinette while the motorhome is in transit

Your motorhome may be equipped with one of the following sofa styles.

Hide-A-Bed Sofa or Sofa Sleeper

The hide-a-bed sofa functions much the same as a regular residential hide-a-bed sofa. To make the hide-a-bed sofa into a bed, remove the seat cushions and pull the sofa back towards you firmly and gently. Activate (or deflate) the air mattress (if so equipped) using the supplied furniture manufacturer’s instructions. To convert the hide-a-bed back into the upright sofa position, reverse the process.

Jack Knife Sofa

The jack knife sofa functions much the same as a residential futon. To make the sofa in to a bed, lift up on the bottom seat cushion and pull it towards you. The sofa back will drop down to provide a sleeping surface. For additional comfort and to reduce fabric damage, you may want to place a cover or air mattress (customer supplied) over the sofa when it is in the sleeping position.

Trifold Sofa

The trifold sofa offers very similar features to the traditional hide-a-bed. The following illustrations detail converting the sofa into a bed.

1. Remove the tri-fold sofa pillows and set aside.
2. Using the strap handle, pull the sleeping surface up, then out.
3. While sleeping surface is up, fold out legs. Extend the sleeping surface until grounded.
4. Once sleeping surface is grounded, fold head board down flat.

SECTION 12: INTERIOR

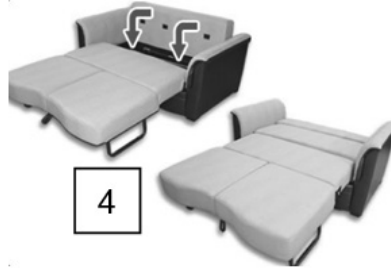
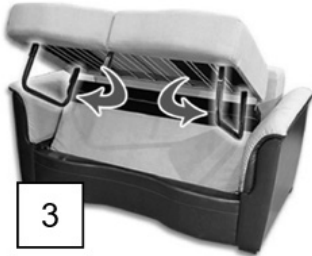

Booth Dinette (if so equipped)

The dinette is designed to seat up to four adults. Depending on your model, there may be a storage area in the dinette bench. To access this storage, remove all the cushions and lift up on the bottom seat support. **If the bottom seat support is secured closed with screws, do not remove the seat support or use this area for storage.**

The dinette seats that are secured with screws contain factory installed equipment and should only be accessed by a qualified service technician.

Your motorhome may be equipped with one of the following dinette styles that can be converted into a bed.

Booth Dinette

Remove all the cushions from the booth dinette. Lift up the tabletop and remove the detachable table legs. Place the tabletop on the ledges provided between the booth dinette benches. Lay the seat back cushions against the back of the dinette bench. Lay the dinette seat bottom cushions in between the seat back cushions. The area where the cushions meet should be slightly raised. Push the raised cushion ends down gently as the cushions are designed to fit snugly. Reverse this process when converting back to the booth dinette.

Dream Dinette

Remove all the cushions from the dinette. Locate the locking mechanism rod under the table top. This locking mechanism is designed to keep the table from collapsing into the bed configuration. Turn this rod so it moves out of the channel and points down toward the floor. Push the dinette table down toward the floor to form the platform for the bed. Arrange the cushions to form a mattress for sleeping. To convert back to a dinette, remove the cushions, pull the table back up as high as it will go, and turn the rod underneath back to the locked position.

⚠ WARNING

Make certain the rod underneath the table is in the locked position before using then the table in the dinette position. Failure to secure the table in the locked position may result in injury or property damage.



Dream Dinette Unlocked



Dream Dinette Locked

Free Standing Dinette Chairs (if so equipped)

Two free standing chairs and two folding chairs are included in the free standing table/chair package (if so equipped). When traveling in the motorhome, it is recommended the free standing dinette chairs be fastened securely at the dinette table, and the folding chairs be secured in a closet or storage area.

⚠ WARNING

Do not allow occupants to occupy the free standing dinette chairs while the motorhome is in transit.

PANTRY OR HUTCH (IF SO EQUIPPED)

Your recreation vehicle may have a pantry or hutch that you can use for storage. Make sure all items stored in the pantry or hutch are secured to prevent shifting during travel. This cabinetry has been designed to accommodate the normal camping items which may be bulky but not necessarily heavy. **Remember your recreation vehicle's load capacity is designed by weight, not volume, so you cannot necessarily use all available space.**

If your pantry or hutch has sliding pantry shelves, they have been equipped with a locking mechanism to keep them in place during transit. To secure the shelf in place, push it all of the way in until the latch tab clicks into place. Always pull out slightly on the shelf to make sure that it is stationary and secure in the transit position. To release the shelf, push in on the tab and pull the shelf slowly towards you.

⚠ WARNING

Your RV's load capacity is designated by weight, not by volume, so you cannot necessarily use all available space when loading the vehicle. Do not exceed your GVWR and ensure you are loading the vehicle as evenly as you can for the best possible handling. Ensure heavy items are secured so they do not shift during travel.

SECTION 12: INTERIOR

COUNTERTOPS

To prevent permanent damage

- Always use hot pads or trivets under hot pans, dishes, or heat producing appliances such as frying pans. Heat will damage the countertop.
- Use a cutting board to prevent unnecessary damage to the countertops. Do not cut directly on the solid surface countertop.
- Avoid harsh chemicals such as drain cleaners, oven cleaners, etc.
- Do not let cleaners with bleach set on the top. Wipe them off promptly.

For additional information on the removal of difficult stains or surface damage repair, refer to the countertop manufacturer's user guide.

Your recreation vehicle may be equipped with one or both of the following countertops.

Laminate countertops (if so equipped)

Glass rings, food spills, water spots and smudges usually wipe off with a damp sponge. Stubborn stains can be removed with a general-purpose spray cleaner. Some stains can be removed by squeezing fresh lemon juice over the stain and allowing the juice to soak for approximately forty-five minutes. After 45 minutes, sprinkle baking soda over the lemon juice and rub with a soft cloth.

Solid surface countertops (if so equipped)

Soapy water, ammonia based cleaners (not window cleaners as they can leave a waxy build up that may dull the surface) or commercially available solid surface cleaners will remove most dirt and residue from all types of finishes. A damp cloth followed by a dry towel will remove watermarks.

Difficult stains can be removed from the matte finish with a green Scotch Brite® pad and a mild abrasive cleaner. Disinfect the surface periodically with diluted household bleach (one part water to one part bleach).

For cuts and scratches, sand the matte finish lightly with (220) fine grit sandpaper until the cut or scratch is gone. Restore finish with a green Scotch Brite® pad and mild abrasive cleaner.

Run cold water when pouring hot/boiling water into the sink.

Solid surface sink maintenance

Occasionally, clean the solid surface sink by filling one-quarter full with a 50/50 water/bleach solution. Let soak for 15 minutes, and then wash sides and bottom of sink as solution drains.

FLOORING

Always test a cleaning agent in an inconspicuous area for colorfastness.

Carpet

Vacuum your carpet regularly. It is important to remove loose soil and debris while it is on the surface. Heavily traveled areas (i.e., walkways, areas in front of the furniture) may be protected with small throw rugs to prolong the life of the carpet.

Prompt attention to spots and spills is essential. Remove as much of the spill as possible. Absorb wet spills as quickly as possible by blotting repeatedly with white paper or cloth towels.

Refer to the manufacturer's guide for detailed cleaning information, or contact a cleaning professional.

Vinyl Flooring

Periodically vacuum or sweep to remove dirt and gritty particles. Although most common spills will not permanently stain the vinyl floors, they are usually easier to remove if wiped up before they set. Blot with a paper towel and wipe clean with a damp cloth. Do not use dish detergents or vinegar and water because they will dull your floor.

To care for the vinyl floor covering, use a damp mop with water and a mild cleaner on the entire floor. **DO NOT SOAK THE FLOORING.** Use care to avoid wetting the carpet edges. To avoid problems of “yellowing” linoleum, the flooring manufacturer recommends avoiding cleaners that contain oil based solvents (i.e. lemon oil, Murphy’s Oil Soap, etc.).

PRIVACY DRAPE INSTALLATION

1. Starting on the driver’s side, attach the black plastic hook to the loop on the wall (behind the driver’s seat). Make sure the Velcro® on the drape is facing the motorhome windshield.
2. Pull the drape towards the windshield and past the driver’s side sun visor. Open the sun visor against the windshield to hold the drape in place.
3. Continue across the windshield to the passenger side, again opening the sun visor and placing the drape behind it.
4. Attach the black plastic hook on the passenger side of the drape, to the loop on the wall behind the passenger’s seat.
5. Attach the Velcro® at the top edge of the drape to the corresponding Velcro® on the cab area roof (above the driver’s and passenger’s doors).
6. Attach the Velcro® at the bottom corners of the drape to the corresponding Velcro® on the wall.

BED STORAGE

Additional storage has been provided under the bed. To access the storage area, grasp the end ledge at the foot of the bed and lift carefully. ***The bed platform must be held when raised.*** It is recommended that two people retrieve stored items from under the bed so that one person may hold the platform, and the other retrieve the stored items from under the bed. Lower the platform slowly to close it. **DO NOT DROP THE PLATFORM.**

Some models may be equipped with a ***prop rod*** to hold open the bed platform. If your model is equipped with a prop rod:

- Raise the platform, release the prop rod from its holder.
- Put the end of the rod in the bracket under the platform.
- To lower the platform, release the prop rod from the bracket under the platform, re-attach the prop rod to the holder on the bed base,
- Lower the platform slowly until closed.

SECTION 12: INTERIOR

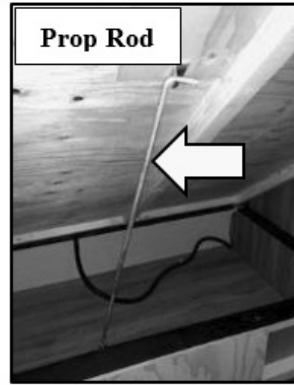
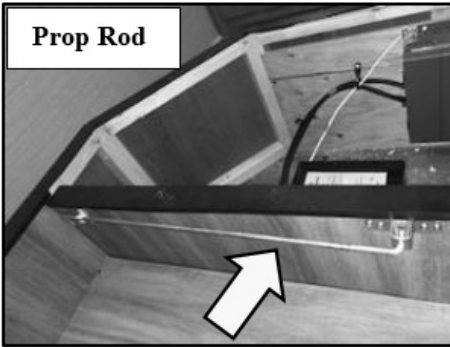

⚠ WARNING

- ❑ Before lifting, be sure there is nothing on the bed that will restrict its movement or add extra weight.
- ❑ Use caution when opening or closing the bed to keep hands and fingers at the end ledge provided (not on the side or farther back than necessary).
- ❑ Exercise extreme caution when opening the bed storage platform. Platform must be held open (unless equipped with a prop rod) and slowly lowered until closed. Failure to comply with these guidelines can result in serious injury or property damage.

The bedroom electric slide room system may be located under the bed. Use care not to obstruct the slide room system when using the under bed storage area.

BUNK BEDS (IF SO EQUIPPED)

Your recreational vehicle may be equipped with bunk style beds. Bunk bed weight ratings will vary depending on the style of bunk bed. Refer to the warnings for bunk beds below.

BUNK BED LADDER (IF SO EQUIPPED)

Your recreational vehicle may be equipped with a ladder to access the upper bunk. This ladder may be a separate steel ladder, or a wooden ladder attached to the bunk beds.

The top of the ladder is secured to the ladder storage compartment. To operate the ladder, lift up and out of the storage tray. Pivot the bottom of the ladder out. Be sure the ladder is securely in place before climbing to the upper bunk.

When storing the wood ladder, place the bottom of the ladder back into the tray in the storage compartment. This keeps it secure during transport and clear of walkways.

The steel ladder (if equipped) would simply hook onto the upper bunk.



NOTE: Some types of bunk beds will not include a ladder.

⚠ WARNING

- Exercise extreme care when entering or exiting the bunk beds and using the ladder (if so equipped).
- Do not allow more than one person on the top bunk.
- Do not allow children under 6 years of age to use the upper bunk.
- Do not allow horseplay on or under the bed and prohibit jumping on the bed.
- Make sure the ladder (if equipped) is anchored properly to the bed.
- Never allow more than one person on the ladder (if equipped) at a time.
- Children should always be supervised when using the ladder (if equipped) or when entering or exiting the bunk beds.
- Weight limit of the bunk ladder (if equipped) is 300 lbs. (136 kg).
- Maximum weight limits for bunk beds
- Bunk bed styles vary according to RV model.
- Maximum weight ratings vary according to bunk bed style.
- Weight rating labels are located at all bunk locations:

Typical
Bunk Bed
Maximum
weight
rating label

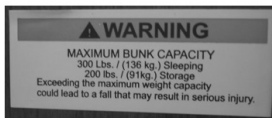

- Do not exceed the weight limits of the bunk bed or the bunk ladder (if equipped).
- Failure to follow these instructions can result in serious bodily injury.

CAB-OVER BUNK BED (IF SO EQUIPPED)

Your motorhome may be equipped with an over-the-cab bunk bed. This bunk bed is accessed through the use of a steel ladder that hooks to the bed platform.

⚠ WARNING

- Exercise extreme care when entering or exiting the bunk bed and using the ladder (if so equipped).
- Do not allow horseplay on the bed and prohibit jumping on the bed.
- Make sure the ladder (if equipped) is anchored properly to the bed.
- Never allow more than one person on the ladder (if equipped) at a time.
- Children should always be supervised when using the ladder (if equipped) or when entering or exiting the bunk bed.
- Capacity of the Cab-Over bunk is 750 lbs. maximum.**
- Weight limit of the bunk ladder is 300 lbs. (136kg) maximum.**
- Do not exceed the weight limits of the ladder or the bunk bed.**
- Failure to follow these instructions can result in serious bodily injury.

SECTION 12: INTERIOR

Notes:

CLEANING THE EXTERIOR

To protect your recreation vehicle's exterior finish, wash it often and thoroughly.

For recreation vehicles with painted exterior graphics: If desired you may wash and wax your vehicle 60 days after purchase. The exterior paint does need time to cure before any wax is applied to the exterior surface. Careful maintenance for the first 60 days will assure a long lasting durable finish.

Your recreation vehicle is exposed to many environmental conditions that have an adverse affect on the paint finish:

- Road Salt and Sodium Chloride
- Road Tar / Bugs
- Bird Droppings / Tree Sap
- Industrial Fallout / Acid Rain /Pollution
- UV Exposure and Moisture

The most common problems resulting from these conditions are corrosion, staining, and chemical spotting. Generally, the longer the foreign material remains in contact with the exterior finish, the more extensive the damage. These problems can be minimized by regularly scheduled washing and polishing. Wash your recreation vehicle as soon as possible if it becomes contaminated with foreign material.

Avoid parking under trees or near ocean sea salt. Ice or snow should not be scraped from the painted surface: Brush off!

Gravel roads should be avoided.

Anti-freeze, gasoline or washer solvents if spilled on the painted surface should be rinsed off with water immediately. Bugs and bird droppings should be rinsed off daily.

Washing

Commercial washing should be avoided. Wash with cold water using a mild liquid soap. Dry wiping with a dry cloth is not recommended.

Make sure the RV's surface temperature is cool, under 90 F, and out of direct sunlight. A shaded area is ideal for washing your vehicle as direct sunlight causes water spotting. Use a mild soap, detergent or car wash shampoo. Try to avoid combination wash-n-wax products as these waxes can cause build up and are designed for smaller surfaces. Have two dedicated sponges or wash mitts: one for the exterior walls and one for the wheels and under carriage. Brushes or wash mitts made of plastic bristles are acceptable for use on tires and wheel wells, but are not intended for use on the exterior walls. Avoid using such items on painted surfaces as they will damage the finish. Wash the wheels and wheel wells first as this removes heavy dirt and debris and prevents it from splattering on panels. Wet the entire area down to remove loose dirt and grime, then hand wash one area at a time using your dedicated paint finish sponge or wash mitt. Wash from the top and work your way down, rinsing frequently to minimize grit abrasion. Follow with a final rinse of water. This process will remove most contamination from the recreation vehicle's surface.

For stubborn stains such as road tar or bug stains, use an ammonia based glass cleaner or a small amount of rubbing alcohol on a damp cloth followed immediately by warm soapy water, and rinsing with clean water. This may not dissolve the road tar, but it will loosen tar and bug stains and remove them from the surface.

Do not use solvent based cleaners on bird droppings or tree sap as these are water based stains. They can be dissolved using ammonia based glass cleaner, warm soapy water and a little "elbow grease". Once again, after removing stubborn stains immediately rinse with clean water.

SECTION 13: EXTERIOR

Drying the recreation vehicle is just as important as washing your vehicle. Tap and well water contain many chemicals that could water stain your vehicle's finish.

We suggest using a damp natural or synthetic chamois. There are other drying products such as lint-free micro-fiber towels that work just as well.

During cold weather

Salt and other chemicals that are spread on winter roads in some geographical areas can have a detrimental effect on the recreation vehicle's underbody. **If your recreation vehicle is exposed to these conditions, spray the underbody with a high-pressure hose every time you wash the exterior of your recreation vehicle.**

Take special care to remove mud or other debris that could trap and hold salt or moisture. After washing your recreation vehicle, wipe off all water drops from the rubber parts around the slideout and doors.



NOTE: When the slideout or door is frozen, opening it by force may tear off or crack the rubber gasket that is installed around the slideout or door. Therefore, pour warm water on the gasket to melt the ice (wipe off the water thoroughly after opening the slideout or door). To prevent the weather stripping from freezing, treat it with a silicone spray.

Waxing

Wax your recreation vehicle once or twice a year, or when painted surfaces do not shed water well. Use a soft cloth to apply a small amount of wax to the painted surfaces. After the wax has dried, polish the recreation vehicle with a dry, soft cloth.

Do not wax your recreation vehicle in direct sunlight. Wax it after the surfaces have cooled.

Do not apply wax to any area having a flat black finish as it can cause discoloration. If the finish has been stained with wax, wipe off the area with a soft cloth and warm water. When waxing the area around the various openings, do not apply any wax on the weather strip. If it is stained with wax, the weather strip cannot maintain a weatherproof seal around the opening.



CAUTION

- Do not use waxes containing high-abrasive compounds. Such waxes remove rust and stains effectively from the paint work, but they are also harmful to the luster of the painted surface since they scrape off the coating. Further, they are detrimental to glossy surfaces, such as the grille, garnish, moldings, etc. do not use gasoline or paint thinners to remove road tar or other contamination to the painted surface.
- Do not use a buffer and a buffing compound as it may damage the exterior surface. Please contact a professional paint body shop for assistance.

Polishing your recreation vehicle

If painted surfaces have been severely damaged and have lost their original luster and color tone, polish the surface lightly with a fine polishing compound. Avoid limiting your polishing to the damaged surface only; polish a somewhat wider area, moving the polishing cloth in one direction. After polishing, flush the compound from the surface and apply a coat of wax to regain a beautiful luster.

Damaged paint

To prevent corrosion, touch up small cracks and scratches in the paint coat as soon as possible with touch-up film or paint. Carefully check the body areas facing the road and the tires for damage to the paint coat caused by flying stones, etc. Use the closest automotive paint (available locally) match possible when touch-up paint is needed.

Cleaning plastic parts

Use a sponge or chamois to clean plastic parts. Use warm water and a soft cloth or chamois to remove any white residue from dark colored plastic surfaces. Do not use a scrubbing brush, other hard tools, or wax containing abrasives as they may damage the plastic surface.

Chrome parts

To prevent chrome parts from spotting or corroding, wash with water, dry thoroughly, and apply a non-abrasive automotive wax. If the chrome is severely damaged or pitted, use a commercially available chrome polish product.

CAUTION

Do not allow plastic to come into contact with brake fluid, engine oil, grease, paint thinner, or battery acid. These will damage plastic. Use a soft cloth and a mild detergent solution to wipe away any such contact.

FRAME

Frames will show signs of rust much sooner when exposed to salty air than in dry air. Also, frames receive heavy abuse from road conditions such as sand, pebbles, objects in the highway, and/or ice inhibiting chemicals, all of which will cause chipping and a blasting effect on the painted surface. Periodically rinse off the frame (or as use requires) removing road grime, tar, oil, mud or salt.

Refer to your Chassis Guide for the chassis manufacturer's maintenance instructions.

FRONT AXLE TIRE ALIGNMENT

The term alignment refers to both the adjustment angles on the steering axle and suspension and tracking of the rear axle. Many factors are considered when establishing proper alignment. Steering components, suspension, wheel bearings and even proper loading will affect your motorhome alignment. Your motorhome chassis was aligned by the manufacturer, and weighed at our facility before shipment to your dealer. It is your responsibility to have the alignment inspected periodically to maintain vehicle steering performance and prevent uneven tire wear as part of your normal maintenance.



NOTE: Always have the alignment checked and adjusted by a qualified shop with the proper equipment to handle heavy vehicles.

SECTION 13: EXTERIOR



NOTE: A road test by the dealer should be included as part of the pre-delivery inspection. The dealer can check for and correct any steering problems before you take delivery of the motorhome..

MUD FLAP (IF SO EQUIPPED)

If your motorhome is equipped with rear wheel mud flaps and/or a deluxe full-width mud flap, periodically check and remove dirt or debris buildup from the mud flaps.



CAUTION

The mud flap(s) should never be tilted towards the exhaust pipe when the motorhome is not in motion or when the motorhome is moving in reverse. Caution should be used when parking the motorhome to assure the mud flap does not become caught or hung up on stationary items on the ground. This could result in damage to the mud flap(s).

EXTERIOR ROOF AND SIDEWALL VENTS

Inspect the roof vents (including sealants) for cracks and keep them clean. Inspect the refrigerator and holding tank vents for blockages from bird nests, spider webs, leaves, etc. All exterior access doors and vents need to be kept clean and free of obstructions (i.e., insect nests, mud daubers, etc.) while the appliances are in use.

WINDOWS



WARNING

To avoid exhaust gas entry into the motorhome, keep windows closed when the chassis or generator engines are running.

Any ventilating window may permit water inside, especially during heavy rainstorms or while driving. This is normal and water should only be seen in the lower track portion of the window frame. Condensation will also cause water to accumulate on windows and in the tracks. Ensure that the escape window latches are properly adjusted (the window will pop open if not adjusted tight enough).

Window glass

The window glass can normally be cleaned with a sponge and water. Use glass cleaner to remove wax, oil, grease, dead insects, etc. After washing the glass, wipe it dry with a clean, soft cloth.

EXTERIOR LADDER (IF SO EQUIPPED)

Your recreation vehicle may be equipped with an exterior roof ladder. The RV roof has decking under the rubber roof membrane to allow you to walk on the roof (with caution) to do maintenance.

⚠ WARNING

- If your recreation vehicle is equipped with a roof ladder, do not leave items attached to it while traveling. The ladder weight capacity should not be exceeded (see ladder capacity label). **DO NOT** exceed this weight limit. There should never be more than one person on the ladder at the same time.
- **Self-Storing ladders:** Make sure to pull all (there may be up to 4) pins to unlock the ladder. All pins **must be re-inserted** when locking the ladder open for use. Failure to do so may result in serious personal injury.

Some models may be equipped with a self-storing ladder mounted to the side of the vehicle.

Self-Storing Ladder operation

1. Pull all the locking pins (arrows) out of the ladder brackets (**Fig. A**).
2. Pull the ladder down and toward you and it will swing away from the RV.
3. When the brackets are extended (**Fig. B**), re-insert the pins (arrows) to lock the ladder in place while in use.
4. To return the ladder to the storage position; pull the locking pins and push the ladder up and in towards the RV.
5. When the ladder is in the storage position, re-insert all locking pins to prevent the ladder from opening while traveling.

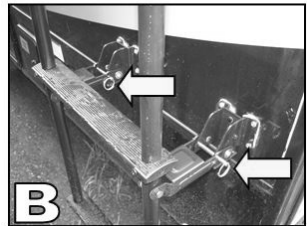
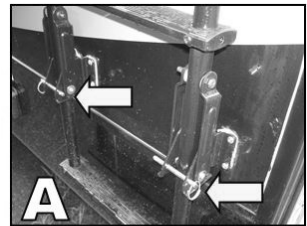

 WARNING

LADDER CAPACITY MAXIMUM

300 lbs (136 kg)

- DO NOT** exceed the ladder maximum weight rating.
- The maximum rating includes the person's weight **PLUS** weight of items carried.
- When climbing:
 - Always face the ladder.
 - Climb slowly with weight centered between side rails.
 - Keep a 3 point contact on the ladder at all times.
 - 3 Point contact - two hands and a foot or two feet and one hand.
- Keep hands free.
 - Use of accessories such as lanyards to keep carried items tethered will keep hands free and prevent falling items.
 - Heavy or bulky items should be brought up only after reaching the roof.
- Do not use the ladder if damaged in any way.

Failure to follow these instructions can lead to ladder collapse, a fall, or dropped items which could result in death or serious injury.

SEALANTS

Sealants perform a very important function and should be inspected closely and regularly maintained. We incorporate many different types of sealants, including butyl/putty, black Butyl-encapsulated foam, silicone (clear and colored), roof sealant and foam. In general, sealants do not have "set" lifetimes.

You or your dealer must:

- Inspect all sealants, a minimum of every six months. A quick walk around the motorhome before leaving may help prevent potential problems during trips and vacations.
- Have the sealant replaced if you notice any cracks, voids, gaps, breaks, looseness or any sign of physical deterioration.
- Always use the same type of sealant that was removed. Your dealer service or parts manager can help you obtain the correct sealant(s).

The sealants may become damaged due to ultraviolet exposure, air pollution, freezing temperatures and exposure to other elements. If deteriorated, repair immediately to prevent damage. Cap seal all trim and openings at least once after the first year and thereafter as cracks, peeling, lifting and shrinkage occur. Conditions such as rain, salt, dust and pollution may increase your vehicle maintenance needs.

 CAUTION

To check the exterior sidewall sealants, use a stepladder placed safely alongside the vehicle. Do not prop a ladder against the body of the motorhome as it may damage the exterior finish

TRAVEL CHECKLIST

Following is a preliminary list of items that need to be checked before leaving your home or campsite. This is a general list, which you may want to customize as you determine your own needs. Refer to your Chassis Guide for information on chassis pre-trip inspections and maintenance.

Safety

- Make sure you follow all safety precautions noted in this owner's manual and in any manufacturer's operators manual when preparing to travel.

Before leaving home (or campsite):

- Make sure all fluids are at proper levels (engine oil, transmission fluid, engine coolant, power steering fluid and windshield washer fluid).
- Check the fuel gauge and lights on the motorhome. **Have someone observe the operation of all exterior lights while you activate the controls. Check the turn signal and high beam indicators on the instrument panel.**
- Examine the tires for excessive tread wear or uneven wear patterns. Check for stones, nails, glass or other objects lodged in the tread. Inspect for tread cuts or sidewall cracks.
- Check tire pressure and correct according to manufacturer specifications.**
- Check wheel nuts for tightness.**
- Inspect and work all interior and exterior latches and locks (lube if necessary).
- Make sure the batteries are fully charged and installed correctly.
- Turn ON the motorhome 12-volt battery disconnect switch.
- Inspect the power cord and carefully clean the contacts if necessary. Plug in the power cord to an appropriate power source.
- Turn on the interior lights and check outlets for polarity. If needed, replace any blown fuses. Check the circuit breakers and test the GFCI circuits.
- Inspect and turn on the propane gas system** (if so equipped). If you have any questions, contact your independent dealer or a qualified propane gas service representative for assistance. If the propane system is functioning properly, test any pilot lights or direct spark ignition features.
- Inspect and test all safety detectors.** If needed, replace any drained or discharged batteries. If you have a defective or damaged safety detector, replace it immediately.
- Inspect the leveling jacks for operation. If needed, perform maintenance as per the manufacturer's information.
- Test all exterior and interior lights. Replace any bulbs that are burnt out.
- Prepare the chassis portion of the motorhome for the camping season in accordance with the Chassis Guide.**
- Wash the exterior of the motorhome. Do a sealant inspection and repair as necessary.
- De-winterize and **sanitize system.**
- If you are towing a vehicle, connect it to the motorhome and test all connections and lights. Test brakes for proper operation.**
- Fill the fresh water tank. Disconnect, drain and store the garden hose on the bracket.*
- Check the seat belt buckles and release mechanisms for positive action and secure connections.

SECTION 14: TRAVEL/CAMPING/STORAGE CHECKLISTS

Before leaving the campsite:

- Check the area* under the motorhome after overnight parking and look for fuel, water, oil or other fluid leaks. If leaks are detected, find the cause and correct it immediately.
- Turn off propane *tanks (if so equipped)*.
- Empty black and gray holding tank, rinse as needed.
- Retract any awnings and secure them for transport.
- Close all the roof vents.
- Close windows & latch blinds.
- Disconnect the cable TV and phone hookups and lower the TV antenna.
- Turn off the interior lights, water heater, furnace and water pump.
- Secure any loose, heavy or sharp objects in the motorhome or exterior compartments.
- Disconnect the power cord and ensure it is stored correctly.
- Disconnect any water connections.
- Water pump and water heater (if applicable) turned off.
- Fasten all interior and exterior doors securely. Lock them (if applicable). Latch drawers, cabinets & doors.
- Move slideout(s) in and lock it in place (if applicable).
- Walk around your motorhome one last time to make sure everything is stored away and the baggage compartments are closed and locked.
- Refrigerator door locked.
- Furnace turned off.
- Make sure the leveling jacks are retracted to the travel position.
- Retract step.
- Secure and lock the entrance door.

MOTORHOME STORAGE

Properly preparing your motorhome for storage during periods of non-usage will prevent problems from arising. It will also make it easier to get started again for the following camping trip or season. To prevent costly freeze-ups, winterize the plumbing system when it will not be in use for an extended period of time, especially if it is stored in colder climates.

Prior to storage:

- Prepare the chassis for storage in accordance to the Chassis Guide. Remember to use fuel additives and supplements if recommended.
- Wash and wax the exterior of the vehicle. Do a sealant inspection and repair as necessary.
- Inspect and clean tires. Check for wear, cracks and inflation pressure.
- Inspect and seal off any area that offers an entry point for rodents, birds or insects. Cover all external outlets (i.e. furnace, vents etc.). Damage from birds, rodents, insect, etc., is not covered under the “Motorized Transferable Limited Warranty” applicable to your motorhome.
- Close all windows, roof vents and range hood vent.
- Turn the furnace thermostat(s) to the OFF position.
- If your motorhome is equipped with a gas/electric DSI range, light a range gas burner to consume any gas remaining in the lines. Once the flame extinguishes itself, turn the burner valve OFF.
- Drain all water lines. Make sure the motorhome is winterized.
- Winterize the toilet and appliances (dishwasher, refrigerator, clothes washer).

SECTION 14: TRAVEL/CAMPING/STORAGE CHECKLISTS

- Drain and flush all holding tanks (fresh water, gray water, black water and/or hot water tanks).
- Adding fuel stabilizer to the generator will aid in preventing condensation and fuel varnishing.
- Turn OFF the motorhome 12-volt battery disconnect switch.
- Turn OFF the inverter mode at remote.
- Disconnect the batteries to prevent battery discharge.
- Remove all perishables from the refrigerator/freezer. Defrost, wash and dry the interior of the refrigerator/freezer and prop (or block) the doors open so air can circulate and prevent mildew.
- Remove all perishables from the cabinets. Leave the cabinets and doors ajar to allow air circulation and prevent mildew and musty odors.
- Lubricate locks and hinges on exterior doors.

While the motorhome is being stored

If the vehicle is stored outside in areas of heavy snow, you should periodically brush the snow off to prevent excessive accumulation and prevent possible roof damage.

SECTION 14: TRAVEL/CAMPING/STORAGE CHECKLISTS

Notes:

FEATURED COMPONENTS QUICK REFERENCE CHART

Your recreation vehicle may be equipped with some of the items listed below. This is a partial listing and it is not intended to cover all components. All information is the latest available at the time of publication. Jayco reserves the right to change any of the following information without notice.

Component	Manufacturer	Website
Air Conditioner	Coleman-Mach	www.airxcel.com/coleman-mach
Antenna, TV	Winegard	www.winegard.com
Awning	Lippert Components Carefree of Colorado Dometic	www.lci1.com www.carefreeofcolorado.com www.dometic.com
Camera, Back up/side view	ASA Electronics Rear View Safety	www.asaelectronics.com www.rearviewsafety.com
Electronic components/systems	See manufacturers' user guide	
Entrance Step	Lippert Components	www.lci1.com
Fan, Exhaust 12V	Atwood Maxx Fan	www.atwoodmobile.com www.airxcel.com/maxxair/products/fans
Fireplace	Twinstar Furrion	www.twinstarhome.com www.furrion.com
Furnace	Atwood	www.atwoodmobile.com
Generator	Onan	www.power.cummins.com/rv
Inverter	Magnum Energy	www.magnumenergy.com
Leveling Jack System	Equalizer Systems Lippert Components	www.equalizersystems.com www.lci1.com
Microwave	See manufacturers' user guide	
Outside Shower / Utility Center	B & B Molders	www.bandbmolders.com
Propane Tank	Manchester Tank	www.mantank.com
Propane/Carbon Monoxide Alarm	See manufacturers' user guide	
Propane Regulator	Manchester Tank	www.mantank.com
Range/stove/cooktop	Atwood Suburban	www.atwoodmobile.com www.airxcel.com/suburban/products/cooking
Range hood	Ventline Inc.	www.ventline.com
Refrigerator	Norcold	www.norcold.com
Safety Alarms	See manufacturers' user guide	
Satellite System	Winegard	www.winegard.com
Tank Sprayer/BLK	B & B Molders	www.bandbmolders.com
Thermostat	Coleman-Mach	www.airxcel.com/coleman-mach

SECTION 15: ADDITIONAL INFORMATION

Toilet	Thetford Corp.	www.thetford.com
Water Heater, Tank DSI	Atwood Greenbrier	www.atwoodmobile.com
Water Heater, Tankless	Girard Systems	www.greenrvproducts.com
Water Pump, 12V	Shurflo East	www.shurflo.com

SECTION 15: ADDITIONAL INFORMATION

Notes:

SECTION 15: ADDITIONAL INFORMATION

Jayco
Ownership Notification
Fax Form To: (800) 825-7876

ATTENTION!

Federal record keeping laws require that we maintain a file of owners of our product. Your cooperation in filling out this form will be appreciated.

Change of Owner

Transfer of Limited Warranty
(see limited warranty for details)

Model Information:

Serial#: _____

Chassis #: _____ Odometer Reading _____
(Motorized only)

New Owner Information:

Purchased Date: _____

Name: _____

Address: _____

City: _____ State/Province: _____ Zip Code _____

Phone # _____ E-Mail Address _____

Previous Owner Information:

Purchased Date: _____

Name: _____

Address: _____

City: _____ State/Province: _____ Zip Code _____

Phone # _____ E-Mail Address _____